

P4200PM / P5000PM

Remote Air Dryer



User's Guide





WARNING:

This product can expose you to chemicals including Lead, which is known to the State of California to cause cancer/birth defects or other reproductive harm. For more information go to www.P65Warnings.ca.gov

1. Welcome & Congratulations

Congratulations on your purchase of a new ALTEC AIR P4200PM / P5000PM Air Dryer! We here at ALTEC AIR are very proud of our products and we are committed to providing you with the best value and service possible.

We are sure that you will be satisfied with your new air dryer and would like to thank you for choosing ALTEC AIR for your air dryer requirements. We also hope that you will continue to choose us for your future air pressure and related product purchases.

For information about this and other ALTEC AIR products, please visit us on the web at:

www.AltecAIR.com

2. Introduction

PLEASE READ THIS USER'S GUIDE THOROUGHLY AND SAVE FOR FUTURE REFERENCE.

This User's Guide is provided for the benefit of our customers and contains information and direction specific to the ALTEC AIR P4200PM / P5000PM Air Dryer. It will cover topics including: safety, specifications, installation, registration, operation, testing, maintenance, replacement parts, service, and troubleshooting issues. Observation and compliance with this User's Guide will ensure the maximum life and efficiency of your air dryer.

This User's Guide should be read thoroughly prior to installing, operating, or servicing the air dryer in order to become familiar with the recommended procedures. This will minimize the possibility of personal injury or damage to the unit due to improper operation or handling.

3. Table of Contents

1. Welcome & Congratulations	3		
2. Introduction	3		
3. Table of Contents.....	4		
4. Safety & Warning Information	6		
5. Overview & Specifications.....	8		
5.1 Product Description	8		
5.2 Key Features	8		
5.3 Technical Specifications	9		
5.4 Dryer Function Overview	10		
6. Installing Your Dryer	11		
6.1 Safety & Warning Information	11		
6.2 Before You Begin	12		
6.3 Included Contents	13		
6.4 Required Tools and Materials.....	13		
6.5 Installation Steps.....	14		
6.6 Installation Checklist	21		
7. Registering Your Dryer.....	21		
8. Operating Your Dryer	22		
8.1 Safety & Warning Information	22		
8.2 Connecting Air Lines to the Dryer	23		
8.3 Powering the Dryer ON & OFF.....	23		
8.4 Opening Doors and Panels.....	24		
8.5 Sliding the Compressor Tray Out	25		
8.6 Depressurizing the Dryer	25		
8.7 Setting the System Pressure	26		
8.8 Setting the Outlet Pressure.....	27		
8.9 Identifying Control Board Components....	28		
8.10 Setting the Low Pressure Alarm Set Point.....	29		
8.11 Setting the Compressor Run Time Alarm30			
8.12 Connecting to Common Alarm Terminal Block.....	31		
8.13 Reconfiguring the Common Alarm.....	31		
9. Testing Your Dryer	32		
9.1 Safety & Warning Information	32		
9.2 Measuring Compressor Amp Draw	33		
9.3 Measuring Voltage to Compressor	34		
9.4 Measuring Incoming Voltage	35		
9.5 Measuring Voltages at Solid State Relay..	36		
9.6 Testing Consistent Heatless Dryer Cycling.....	38		
9.7 Testing Unloader Valve	39		
9.8 Measuring Heatless Dryer Solenoid Voltage.....	41		
9.9 Testing Fan	42		
9.10 Testing Cabinet Heater	43		
9.11 Testing Compressor ON/OFF Cycling ...	44		
9.12 Testing Compressor Excessive Run Time Alarm.....	45		
9.13 Testing Humidity Alarm and System Shutdown	46		
9.14 Testing Humidity Open Circuit, Bypass Valve, and Shutdown.....	48		
9.15 Testing Low Outlet Pressure Alarm.....	50		
9.16 Testing Air Fittings & Hoses for Leaks ..	52		
10. Maintaining Your Dryer	53		
10.1 Safety & Warning Information	53		
10.2 Six Month Maintenance	55		
11. Replacement Parts & Accessories	56		
11.1 Upper Section Parts	56		
11.2 Front Panel Assembly Parts	57		
11.3 Internal Cabinet Parts.....	58		
11.4 Heatless Dryer Assembly Parts.....	59		
11.5 Lower Section Parts	60		

11.6 Compressor Assembly Parts	61	13.13 Can't Create a Compressor Excessive Run Time Alarm	72
11.7 Accessories for Your Dryer	62	13.14 Compressor Rapid ON/OFF Cycling	72
11.8 Ordering Parts from ALTEC AIR	63	13.15 Contacting ALTEC AIR Technical Support.....	73
12. Service & Repair.....	64	14. Appendix	74
12.1 Services Offered	64	14.1 Wiring Diagram	74
12.2 Initiating a Service Transaction	64	14.2 Set Point Limits and Defaults	76
13. Troubleshooting Your Dryer	65	15. Limited Warranty Agreement.....	77
13.1 Before You Call ALTEC AIR	65	Registration Reminder	77
13.2 Safety & Warning Information	65	16. Contacting ALTEC AIR	78
13.3 Air Dryer Won't Power ON.....	67	16.1 General.....	78
13.4 Low Outlet Pressure Alarm	67	16.2 Sales.....	78
13.5 Can't Create a Low Pressure Alarm	67	16.3 Service	78
13.6 High Humidity.....	68	16.4 Technical Support.....	78
13.7 Can't Create a High Humidity Alarm / Shutdown.....	69	17. Notes.....	79
13.8 Inconsistent Heatless Dryer Cycling.....	69		
13.9 Compressor Doesn't Operate.....	70		
13.10 Compressor Won't Build Pressure	70		
13.11 Compressor Excessive AMP Draw.....	71		
13.12 Compressor Excessive Run Time Alarm.....	71		

4. Safety & Warning Information

This section contains general information about safety and warning points to consider and adhere to during installation, operation, and maintenance of your air dryer. **PLEASE READ THIS SECTION BEFORE PERFORMING ANY OPERATION OR PROCEDURE ON YOUR AIR DRYER.**

Additional warnings specific to an operation or procedure will also be presented throughout the following sections. These will include the  symbol as well as a label of “**WARNING!**”, “**CAUTION!**”, or “**IMPORTANT!**”. Please be sure to pay close attention for these warnings and read them as you encounter them.



WARNING!

For your safety, all the information in this User's Guide must be followed to minimize the risk of electrical shock, and prevent property damage or personal injury.



WARNING!

Extreme care should be exercised to avoid contact with live electrical circuits. Many procedures performed during installation, operation, testing, and maintenance of this air dryer require the equipment to be running, creating a situation for potential electrical shock. It is highly recommended that you remove all jewelry before performing any procedures.



WARNING!

Internal surfaces may be hot. Use care when coming into contact with internal components as there is a potential for some of these components to become hot when in operation or standby.

**CAUTION!**

Proper Installation & Maintenance as outlined in this User's Guide is extremely important to ensure the reliability and longevity of the equipment as well as prevent damage or personal injury.

**CAUTION!**

Depressurizing the air dryer may be necessary before performing certain procedures. **NEVER** remove pressure sensing tubes from the Control Board without depressurizing the air dryer first, or **damage to the Control Board will occur.**

**CAUTION!**

Incoming power to dryer must be 110 - 125 VAC, 1 Phase, 50/60 Hz with minimum 30 amp service with a 25 amp slow blow fuse. If hard-wiring directly, refer to local NEC guidelines.

**CAUTION!**

This Air Dryer does not contain an internal Surge Protection Device (SPD). If an SPD is required it must be supplied by the user.

**CAUTION!**

Observe precautions for handling **Electrostatic Sensitive Devices.**

**IMPORTANT!**

Performing routine maintenance as outlined in the *Maintaining Your Dryer* section will ensure optimal performance over the lifecycle of your air dryer.

**IMPORTANT!**

Performing procedures not described in this User's Guide or installing components not supplied by PUREGAS is **NOT RECOMMENDED AND MAY VOID THE WARRANTY.**

5. Overview & Specifications

5.1 Product Description

The P4200PM / P5000PM Air Dryer from ALTEC AIR is designed to intake wet ambient air and remove the moisture for delivery to applications requiring a constant, on-demand source of dry, pressurized air. This process is fully automatic and will remain consistent with minimal required periodic maintenance. This dryer is designed specifically for outdoor use.

The P4200PM / P5000PM Air Dryer employs the principles of compression and pressure swing adsorption. The operation is fully automatic and relatively maintenance free. The unit offers the necessary gauges and controls to ensure the delivery of dry air at proper pressure and humidity, along with removable component assemblies allowing easier access for adjustment and maintenance.

5.2 Key Features

- Solid state based circuitry eliminates costly maintenance
- Accurate humidity sensing within $\pm 0.1\%$ RH
- Removable compressor tray, front panel, and heatless dryer for easy maintenance
- Oil-less type compressor

5.3 Technical Specifications

	P4200PM	P5000PM
Output Capacity Normal: Maximum:	2,600 SCFD continuous 4,200 SCFD emergency	3,000 SCFD continuous 5,000 SCFD emergency
Power Requirements	110 - 125 VAC, 1 Phase, 50/60 Hz (30 Amp service recommended)	
Running Amps	12 Amps	16 Amps
Outlet Pressure Range	0 – 20 PSI (adjustable)	
Outlet Air Humidity	Less than 2% RH	
Compressor Type	2-cylinder, 3/4 HP, Rocker, oil-less	2-cylinder, 1 HP, Piston, oil-less
Drying Method	Heatless Desiccant	
Operating Temperature Range	-40° to 120° F (-40° to 48° C) (Optimal: 40° to 85° F (5° to 30° C))	
Noise Level:	48 dBA at 3'	68 dBA at 10'
Alarms	Standard alarms – Complete measurement of all critical points	
Outlet Connections	1/2" NPT Female	
Dimensions	23.25" D x 17.5" W x 47.75" H (59.0 cm x 44.5 cm x 121.3 cm)	
Net / Shipping Weight	212 lbs (96 kgs) / 233 lbs (106 kgs)	255 lbs (116 kgs) / 276 lbs (125 kgs)

5.4 Dryer Function Overview

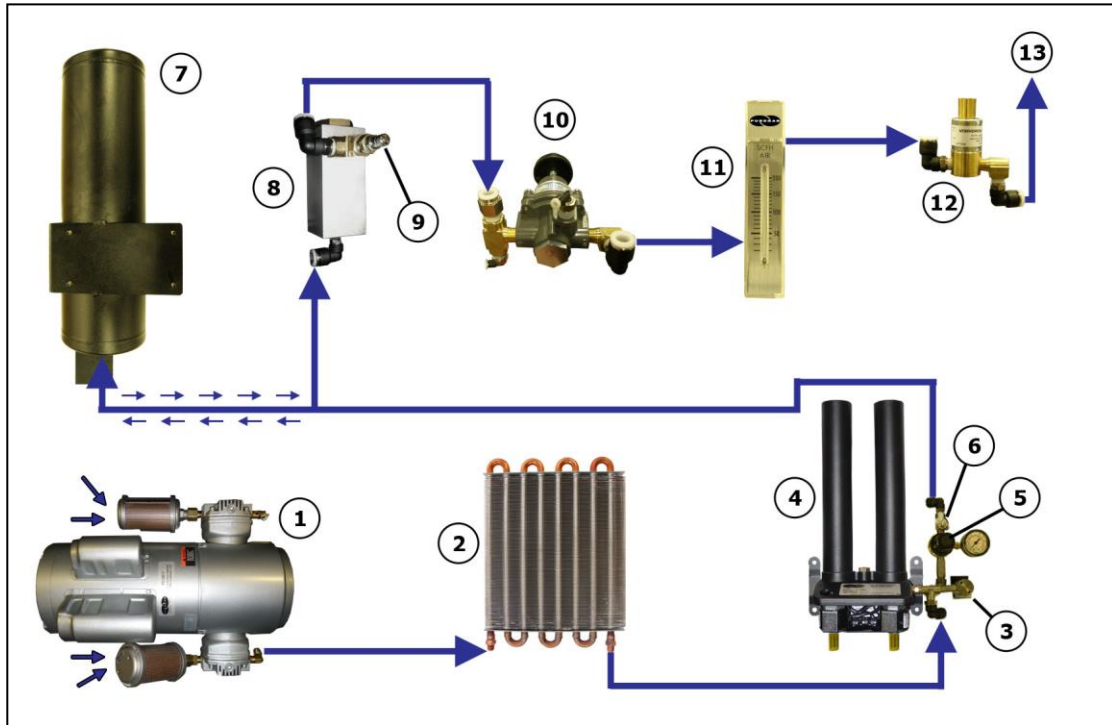

#	Component	Description
1	Compressor	Compresses drawn in ambient air.
2	Precooler	Cools compressed air prior to drying function.
3	Unloader Valve	Relieves excess compressor head pressure.
4	Heatless Dryer	Removes moisture from compressed air.
5	Capacity Control Valve	Regulates system pressure and prevents air from bleeding back through the heatless dryer.
6	Safety Relief Valve	Prevents system from over pressurizing by releasing at high pressure.
7	Air Tank	Stores dry compressed air.
8	Humidity Sensor	Measures the humidity of the compressed air.
9	F-Type Valve	Provides a point to test system Humidity with an external tester.
10	Outlet Pressure Regulator	Regulates the outlet pressure.
11	Flow Meter	Measures the flow of compressed air.
12	Bypass Valve	Bypasses wet humid air to atmosphere.
13	Pressure Outlet	Outputs the pressure set by the Outlet Pressure Regulator.

6. Installing Your Dryer

6.1 Safety & Warning Information



WARNING!

Internal surfaces may be hot. Use care when coming into contact with internal components as there is a potential for some of these components to become hot when in operation or standby.



WARNING!

Extreme care should be exercised to avoid contact with live electrical circuits. Many procedures performed during installation, operation, testing, and maintenance of this air dryer require the equipment to be running, creating a situation for potential electrical shock. It is highly recommended that you remove all jewelry before performing any procedures.



CAUTION!

Proper Installation & Maintenance as outlined in this User's Guide is extremely important to ensure the reliability and longevity of the equipment as well as prevent damage or personal injury.



CAUTION!

Incoming power to air dryer must be 110 - 125 VAC, 1 Phase, 50/60 Hz with minimum 30 amp service with a 25 amp slow blow fuse. If hard-wiring directly, refer to local NEC guidelines.

**CAUTION!**

This Air Dryer does not contain an internal Surge Protection Device (SPD). If an SPD is required, it must be supplied by the user.

**IMPORTANT!**

Performing procedures not described in this User's Guide or installing components not supplied by PUREGAS is **NOT RECOMMENDED AND MAY VOID THE WARRANTY.**

6.2 Before You Begin

6.2.1 Carefully inspect the unit, including the shipping box as well as the air dryer, for ANY DAMAGE CAUSED BY SHIPPING. If any shipping damage is detected, it is important to file a claim with the shipping company prior to continuing the installation procedures.

6.2.2 Read the entire *Installing Your Dryer* section to familiarize yourself with the components and procedures before performing the air dryer installation.

6.2.3 Verify the installation location of the air dryer:

6.2.3.1 Well secured location

6.2.3.2 ALTEC AIR recommends the air dryer be mounted a minimum of one (1) foot from the ground.

6.2.3.3 Ambient temperature lower than 120°F (85° F optimal).

NOTE: Higher temperatures will decrease component lifespan.

6.2.3.4 Meets the following power requirements:

- 110 - 125 VAC, 50/60 Hz
- Minimum 30 amp service with a 25 amp slow blow fuse
- If hard-wiring directly, refer to local NEC guidelines

6.2.4 Notify the alarm center of the installation and potential for alarms during the process (as necessary).

6.3 Included Contents

(1) P4200PM / P5000PM Air
Dryer

Package located inside the dryer:

- (1) Compressor Connector
Tool
- (1) User's Guide (not
shown)

**6.4 Required Tools and Materials**

- Large adjustable wrench
- 7/16" wrench
- Band cutters or snips
- 5/16" nut driver
- Medium Phillips head
screwdriver
- Pipe dope or pipe thread tape
- Cup of soapy water
- 1-inch paint brush
(recommended)

6.5 Installation Steps

6.5.1 Remove all shipping materials and hardware.

NOTE: If ANY SHIPPING DAMAGE is detected, file a claim with the shipping company prior to continuing the installation procedures.



6.5.2 Open the front door.



6.5.3 Check for loose parts, hoses, or wiring.

NOTE: If ANY SHIPPING DAMAGE is detected, file a claim with the shipping company prior to continuing the installation procedures.



6.5.4 Remove the ship-loose contents package.



6.5.5 Pull out and rotate the quick pins ¼ turn to lock in the Open position.

6.5.6 Pull the Compressor Tray out.

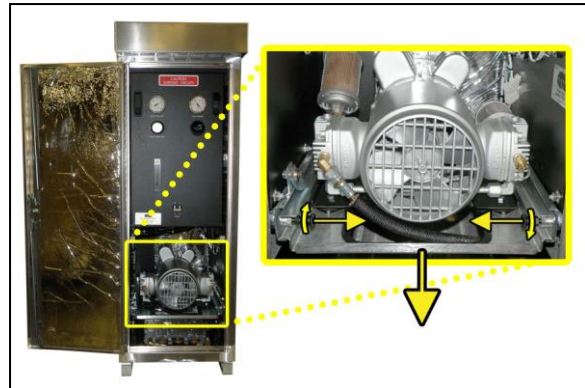

6.5.7 With a 7/16" wrench remove the shipping blocks from under the compressor plate.

Discard blocks and bolts.

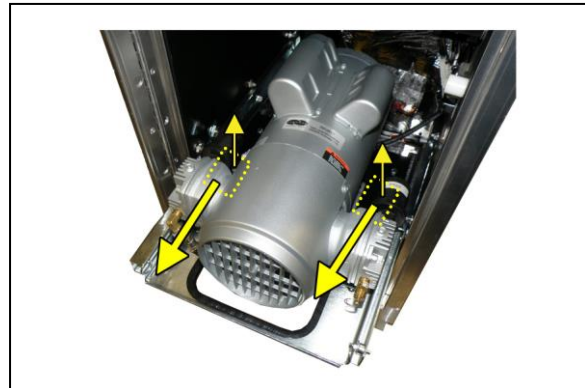

6.5.8 Slide the Compressor Tray into place.

6.5.9 Rotate the quick pins ¼ turn to the Lock position.

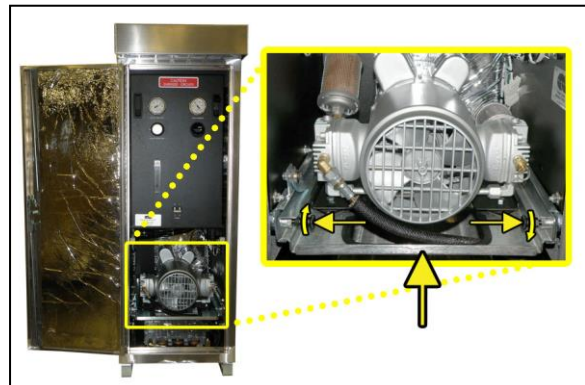

6.5.10 Place the dryer at the operating location.

NOTE: Close the front door if necessary.

6.5.11 Verify that the dryer is powered **OFF**.

6.5.12 Depress the latches and lower the front panel.



6.5.13 Route incoming power through strain relief fitting on the back where shown.

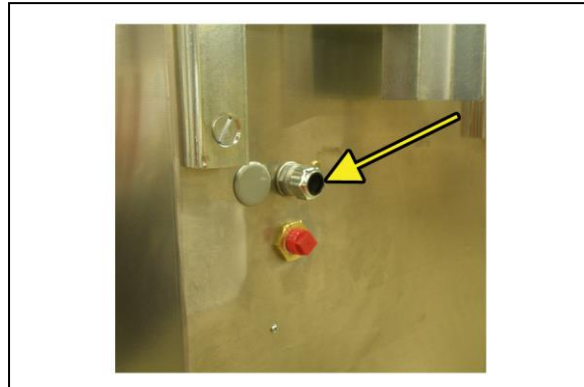

6.5.14 With a 5/16" nut driver, remove the cover from the terminal block.

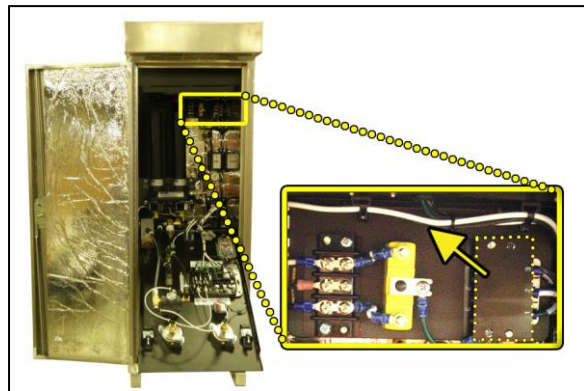

6.5.15 With a screwdriver, wire power to the terminal block of the dryer.

6.5.16 Reinstall the terminal block cover.

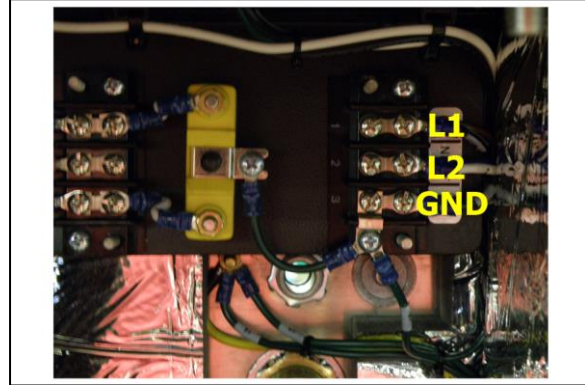

6.5.17 Tighten the strain relief.

6.5.18 Remove dust plug and connect the air supply line to the dryer Outlet Pressure port.

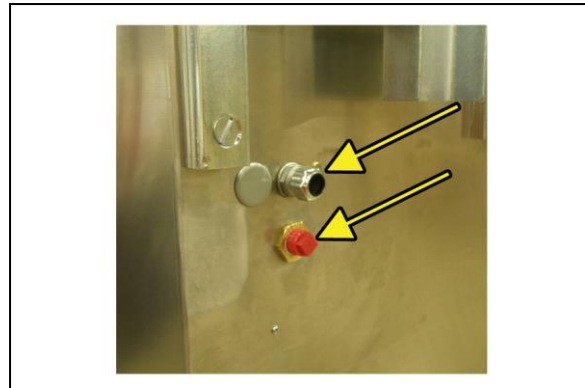

6.5.19 Close the front panel.

6.5.20 Power the dryer ON.



⚠ IMPORTANT: Press **RESET** if the dryer goes into **SHUTDOWN** due to Humidity.

6.5.21 Set the System Pressure:

6.5.21.1 Lower the front panel.



With Compressor running:

6.5.21.2 Pull the Capacity Control Valve knob out.



6.5.21.3 Turn the knob until the reading on the pressure gauge is **50 PSI**.

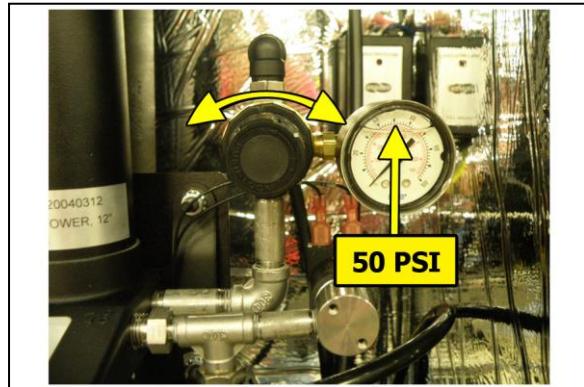

6.5.21.4 Push the knob in, to lock.

6.5.22 Set the Outlet Pressure:

6.5.22.1 Close the front panel.

6.5.22.2 Loosen the Outlet Pressure Regulator Locknut.



6.5.22.3 Turn knob until Outlet Pressure (OUTP) reading is at the desired setting.

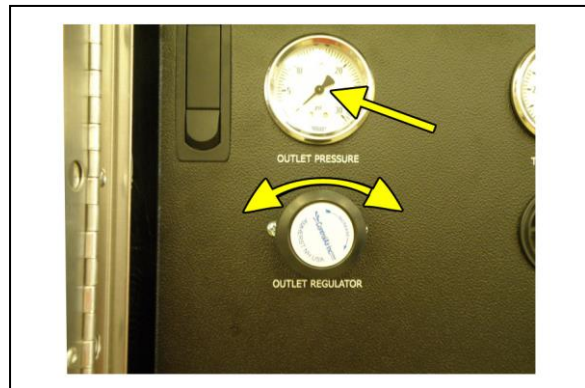

6.5.22.4 Tighten nut to lock.

6.5.23 Check for air leaks:

NOTE: This is a general procedure that can be applied to any fitting or hose that has air pressure in it. **DO NOT SOAP TEST THE HUMIDITY SENSOR. DAMAGE TO THE SENSOR MAY OCCUR.**

With Compressor **NOT** running:

6.5.23.1 Listen for any 'hissing' sounds which may indicate a fitting or hose air leak.

With Compressor running:

6.5.23.2 Use a 1-inch paint brush to dab soapy water on the air fitting or hose connection to be tested.

If air bubbles appear at the connection, this indicates that air is leaking from the connection.



If any leaks are detected, take steps to seal them off (as necessary):

- *Tighten the fitting*
- *Re-connect the hose end*
- *Replace the fitting/hose/component*

6.5.24 Close the front panel and depress latches.

6.5.25 Close the front door and latch.



6.5.26 REGISTER YOUR DRYER. *See section 7. for details.*

6.6 Installation Checklist

- No shipping damage was detected.
- Dryer location meets the following requirements:
 - Well secured location
 - Mounted a minimum of one (1) foot from the ground (Recommended)
 - Ambient temperature lower than 120°F (85° F optimal)
- Shipping blocks removed from compressor tray.
- System Pressure is set to 50 PSI.
- No air leaks are present in the system.
- No alarms are present.

7. Registering Your Dryer

Please take a moment to register your ALTEC AIR P4200PM / P5000PM Air Dryer. Registering is necessary to activate the Limited Warranty on your product. Once you register, you are eligible to receive free technical support, as well as updates concerning your ALTEC AIR products.

Register Online at www.AltecAIR.com/registration

Or by Phone 1-800-521-5351 (**option 2**)

Have the following information available:

Model #: _____ **Serial #:** _____

Company Name: _____ **Location Name:** _____

Shipping Address: _____

City: _____ **State:** _____ **Zip Code:** _____

Contact Name: _____ **Phone #:** () - ext. _____

Email: _____

8. Operating Your Dryer

8.1 Safety & Warning Information



WARNING!

Extreme care should be exercised to avoid contact with live electrical circuits. Many procedures performed during installation, operation, testing, and maintenance of this air dryer require the equipment to be running, creating a situation for potential electrical shock. It is highly recommended that you remove all jewelry before performing any procedures.



WARNING!

Internal surfaces may be hot. Use care when coming into contact with internal components as there is a potential for some of these components to become hot when in operation or standby.



CAUTION!

Observe precautions for handling **Electrostatic Sensitive Devices.**



IMPORTANT!

Performing procedures not described in this User's Guide or installing components not supplied by PUREGAS is **NOT RECOMMENDED AND MAY VOID THE WARRANTY.**

8.2 Connecting Air Lines to the Dryer

8.2.1 Remove dust plug from the back of the Dryer and connect the air supply line to the dryer Outlet Pressure port.

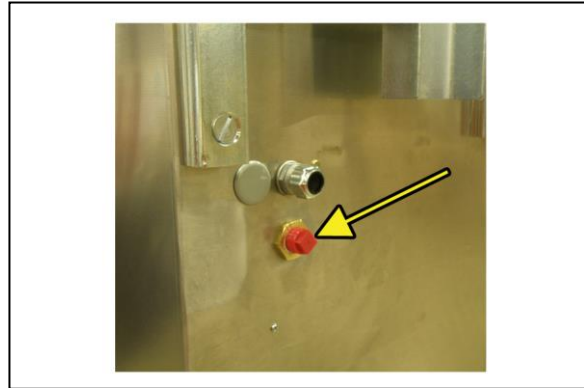

8.3 Powering the Dryer ON & OFF



CAUTION!

Incoming power to dryer must be 110 - 125 VAC, 1 Phase, 50/60 Hz with minimum 30 amp service with a 25 amp slow blow fuse. If hard-wiring directly, refer to local NEC guidelines.

8.3.1 POWER Circuit Breaker - Controls the main power to the Dryer.



8.4 Opening Doors and Panels

8.4.1 Open the Front Door.



8.4.2 Depress the latches and lower the Front Panel.



8.4.3 Remove wing nut and washer. Open Top Cover.

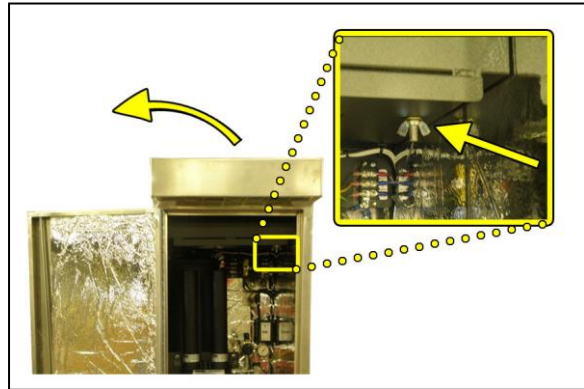

8.5 Sliding the Compressor Tray Out

8.5.1 Pull out and rotate the quick pins $\frac{1}{4}$ turn to lock in the Open position.

8.5.2 Pull the Compressor Tray out.

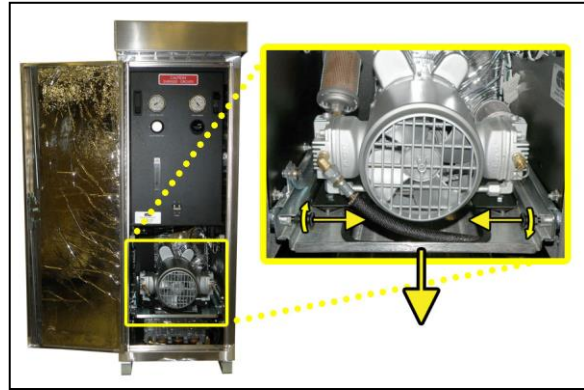

8.6 Depressurizing the Dryer

8.6.1 Open the Front Door (section 8.4.1).

8.6.2 Lower the Front Panel (section 8.4.2).

8.6.3 Pull the ring on the Safety Relief Valve **OUT** until all of the air pressure is released from the system.

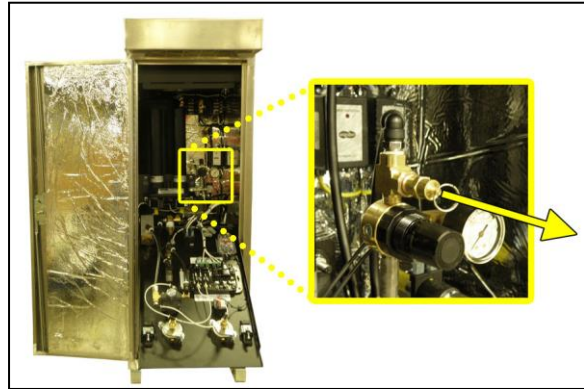

8.6.4 Raise the Front Panel.

NOTE: To prevent air pressure from building back up, power the Dryer OFF (section 8.3).

8.6.5 Close the Front Door.

8.7 Setting the System Pressure

8.7.1 Open the Front Door (section 8.4.1).

8.7.2 Lower the Front Panel (section 8.4.2).

With Compressor running:

8.7.2.1 Pull the Capacity Control Valve knob out.



8.7.2.2 Turn the knob until the reading on the Pressure Gauge is **50 PSI**.

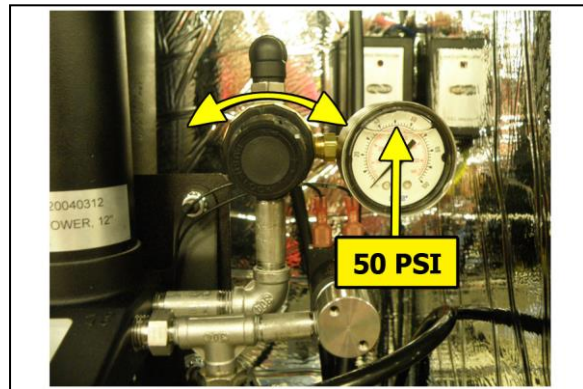

8.7.2.3 Push the knob in, to lock.

8.7.3 Raise the Front Panel.

8.7.4 Close the Front Door.

8.8 Setting the Outlet Pressure

8.8.1 Open the Front Door (section 8.4.1).

8.8.2 Loosen the Outlet Pressure Regulator Locknut.



8.8.3 Turn knob until Outlet Pressure reading is at the desired setting.

8.8.4 Tighten nut to lock.

8.8.5 Close the Front Door.

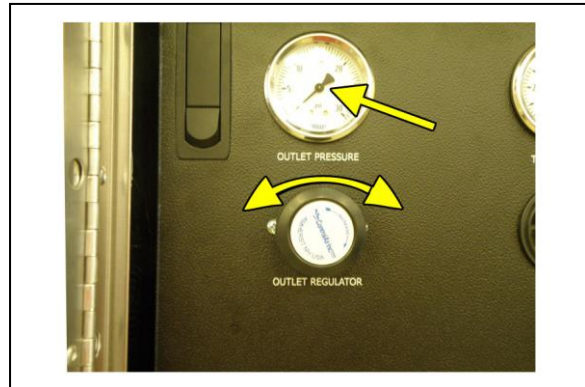

8.9 Identifying Control Board Components

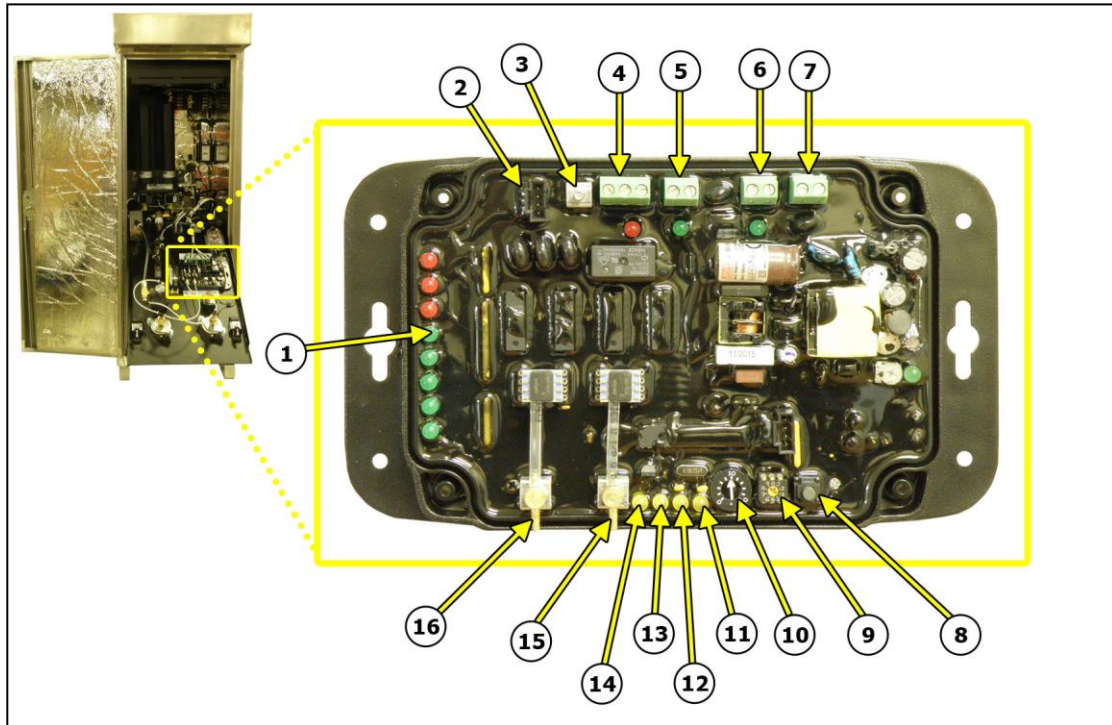

#	Component	Description
1	Humidity Indicators	Indicates the level of the dryer's Humidity <2% - >15%
2	Humidity Sensor	Connector for the Humidity Sensor
3	Ground Lug	Board Ground
4	Common Alarm TB	Open on Alarm – Common – Close on Alarm
5	Solid State Relay TB	SSR (Pos) and SSR (Neg) Connection
6	Bypass Valve TB	Humidity Bypass Valve Connection
7	Control Board Power TB	Incoming Power to the Control Board (115VAC)
8	Reset Button	Resets current alarms
9	Comp Run Time Adjustment	Sets the Compressor Run Time Alarm
10	Low Pressure Adjustment	Sets the Low Pressure Alarm
11	Open Circuit LED	Indicates an Open alarm in the Humidity Circuit
12	Humidity LED	Indicates a Humidity Alarm
13	Run Time LED	Indicates a Compressor Run Time Alarm
14	Low Pressure LED	Indicates a Low Pressure Alarm
15	Outlet Pressure Sensor	Measures the Outlet Pressure
16	Tank Pressure Sensor	Measures the Pressure in the Tank

8.10 Setting the Low Pressure Alarm Set Point

8.10.1 Open Front Door (section 8.4.1).

8.10.2 Loosen the Outlet Pressure Regulator Locknut.



8.10.3 Turn knob until Outlet Pressure reading is at the desired alarm setting.

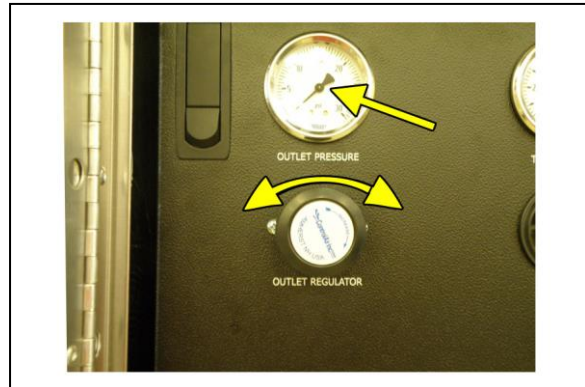

8.10.4 Lower the Front Panel (section 8.4.2).

8.10.5 Locate Low Pressure Adjustment (section 8.9).

8.10.6 Turn Adjustment Arrow fully counter-clockwise.

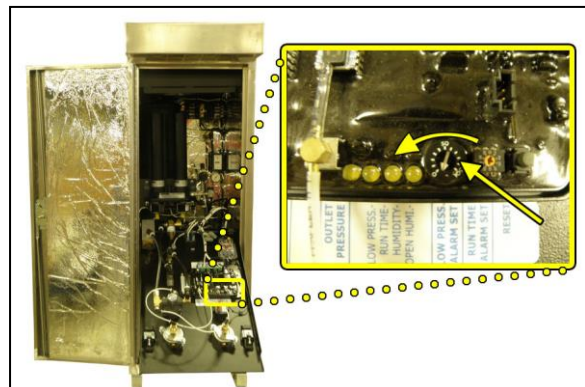

8.10.7 Turn Low Pressure

Adjustment slowly clockwise until Low Pressure LED begins to blink.

NOTE: The blinking LED indicates a conditional alarm. After 5 minutes the LED will illuminate solid indicating a latched alarm.

**8.10.8 Raise the Front Panel.**

8.10.9 Set Outlet Pressure to desired normal setting. (Section 8.8).

8.10.10 Close the Front Door.

8.11 Setting the Compressor Run Time Alarm

8.11.1 Open Front Door (section 8.4.1).

8.11.2 Lower the Front Panel (section 8.4.2).

8.11.3 Locate Compressor Run Time Adjustment (section 8.9).

8.11.4 Turn Adjustment Arrow to desired alarm minute.

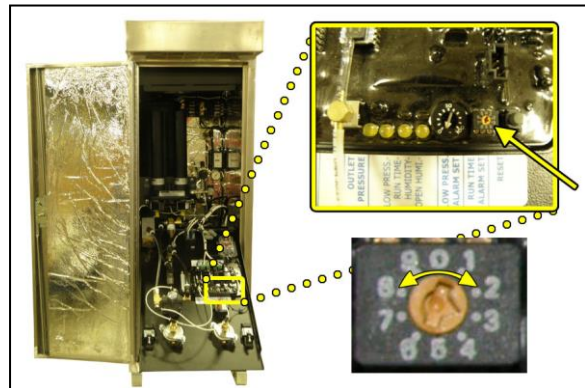

NOTE: Each number represents the alarm in minutes 1-9 and 0 = 10 minutes.

8.11.5 Close and latch the Front Panel.

8.11.6 Close the Front Door.

8.12 Connecting to Common Alarm Terminal Block

NOTE: The Common Alarm Socket is wired as a CLOSE ON ALARM.

8.12.1 Open Front Door (section 8.4.1).

8.12.2 Locate the Common Alarm Terminal Block.

8.12.3 Wire the Common Alarm wire pair on the Terminal Block as required.

8.12.4 Close Front Door.



8.13 Reconfiguring the Common Alarm

NOTE: The Common Alarm is wired as a CLOSE ON ALARM.

8.13.1 Open Front Door (section 8.4.1).

8.13.2 Open the Front Panel (section 8.4.2).

8.13.3 Locate the Common Alarm Terminal Block on the Control Board (section 8.9).

8.13.4 Re-wire #11 on the Common Terminal Block as required.

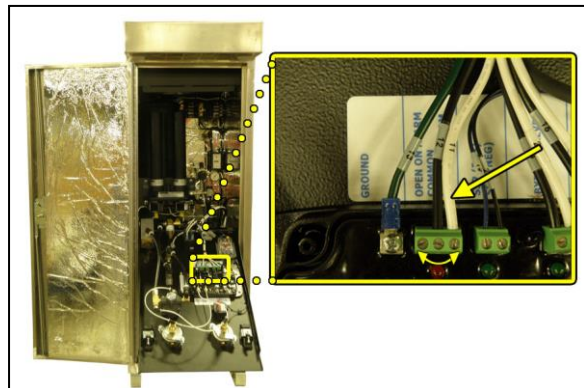

8.13.5 Close and latch the Front Panel.

8.13.6 Close the Front Door.

9. Testing Your Dryer

9.1 Safety & Warning Information



WARNING!

Extreme care should be exercised to avoid contact with live electrical circuits. Many procedures performed during installation, operation, testing, and maintenance of this air dryer require the equipment to be running, creating a situation for potential electrical shock. It is highly recommended that you remove all jewelry before performing any procedures.



WARNING!

Internal surfaces may be hot. Use care when coming into contact with internal components as there is a potential for some of these components to become hot when in operation or standby.



CAUTION!

Depressurizing the air dryer may be necessary before performing certain procedures. **NEVER** remove pressure sensing tubes from the control board without depressurizing the air dryer first, or **damage to the control board will occur.**



CAUTION!

This Air Dryer does not contain an internal Surge Protection Device (SPD). If an SPD is required, it must be supplied by the user.



CAUTION!

Observe precautions for handling **Electrostatic Sensitive Devices.**

9.2 Measuring Compressor Amp Draw



WARNING!

Internal surfaces may be hot. Use care when coming into contact with internal components as there is a potential for some these components to become hot when in operation or standby.

9.2.1 Open Front Door (section 8.4.1).

9.2.2 Slide out Compressor Tray (section 8.5).

With the Compressor running:

9.2.3 Locate the BLACK wire (#3) coming directly from the compressor.

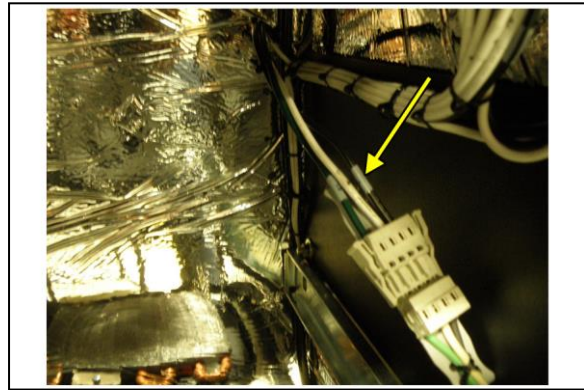

9.2.4 Use an Amp Meter to measure the running amps. With the compressor running, the running amps should measure **11.0 amps or below (P4200PM)** or **15.0 amps or below (P5000PM)**



9.2.5 Slide in Compressor Tray.

9.2.6 Close Front Door.

If the compressor measures over stated running amps, see section 13.11 for troubleshooting information.

9.3 Measuring Voltage to Compressor



WARNING!

Extreme care should be exercised to avoid contact with live electrical circuits. It is highly recommended that you remove all jewelry before performing any procedures.

9.3.1 Open Front Door (section 8.4.1).

9.3.2 Power the air dryer **OFF** (section 8.3).

9.3.3 Slide out Compressor Tray (section 8.5).

9.3.4 Locate the Compressor power connector.

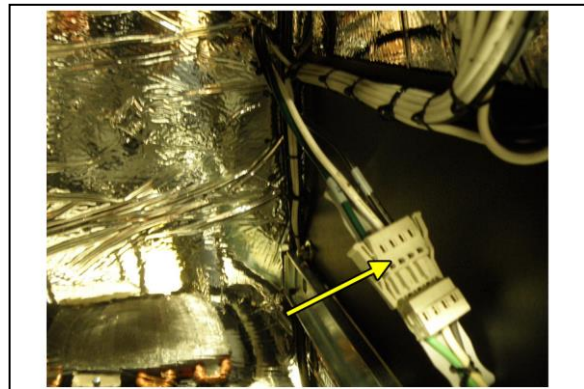

9.3.5 Power the air dryer **ON** (section 8.3).

9.3.6 Use a Voltmeter to measure the voltage:

9.3.6.1 Place the probes in the openings of wire #s 3 and 4 of the power connector.

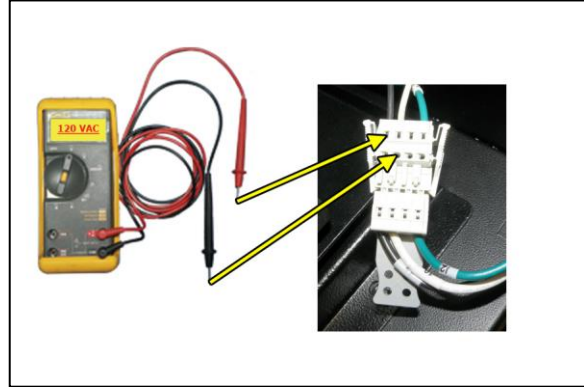

The voltage should measure **110 - 125 VAC**.

9.3.7 Slide in Compressor Tray.

9.3.8 Close Front Door.

9.4 Measuring Incoming Voltage



WARNING!

Extreme care should be exercised to avoid contact with live electrical circuits. It is highly recommended that you remove all jewelry before performing any procedures.

9.4.1 Open Front Door (section 8.4.1).

9.4.2 Lower Front Panel (section 8.4.2).

9.4.3 Locate the **POWER** Circuit Breaker inside the front panel of the air dryer.

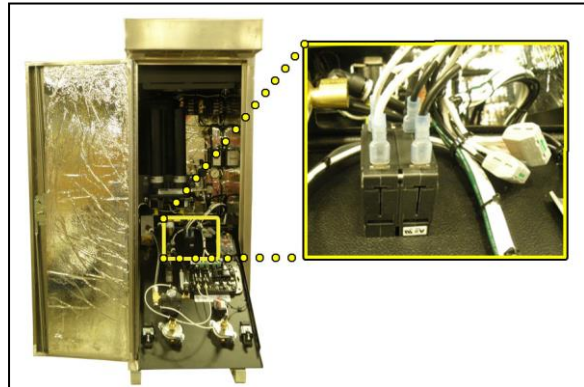

9.4.4 Use a Voltmeter to measure the voltage:

9.4.4.1 Place the probes between the Circuit Breaker and terminal insulation so that they touch the metal contacts.

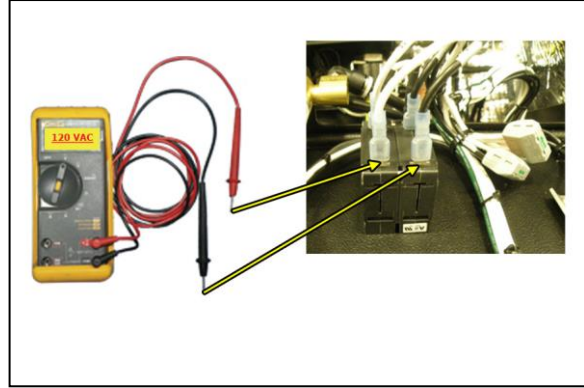

The voltage should measure **110 - 125 VAC**.

9.4.5 Close Front Panel.

9.4.6 Close Front Door.

If the incoming voltage measures less than 110 VAC, it is recommended that steps be taken at your facility to increase the power to the recommended level of 110-125 VAC.

9.5 Measuring Voltages at Solid State Relay

9.5.1 Open Front Door (section 8.4.1).

9.5.2 Open Front Panel (section 8.4.2).

9.5.3 Locate the Solid State Relay inside the front panel of the air dryer.

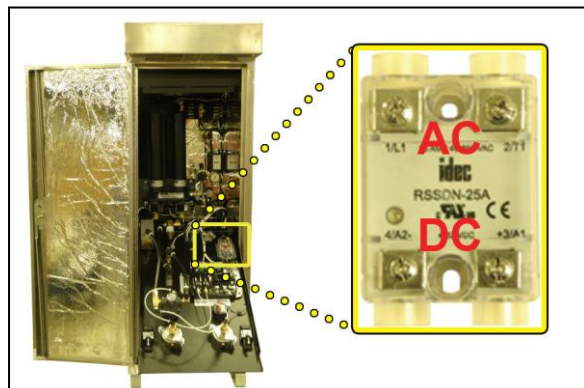

With the Compressor running:

9.5.4 Use a Voltmeter to measure across the AC terminals.
Should measure **0 VAC**.

9.5.5 Use a Voltmeter to measure across the DC terminals.
Should measure **5 - 24 VDC**.

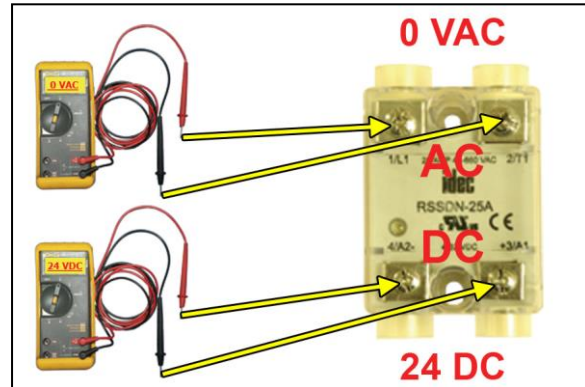
**With the Compressor NOT running:**

9.5.6 Use a Voltmeter to measure across the AC terminals.
Should measure **110 - 125 VAC**.

9.5.7 Use a Voltmeter to measure across the DC terminals.
Should measure **0 VDC**.

9.5.8 Close Front Panel.

9.5.9 Close Front Door.

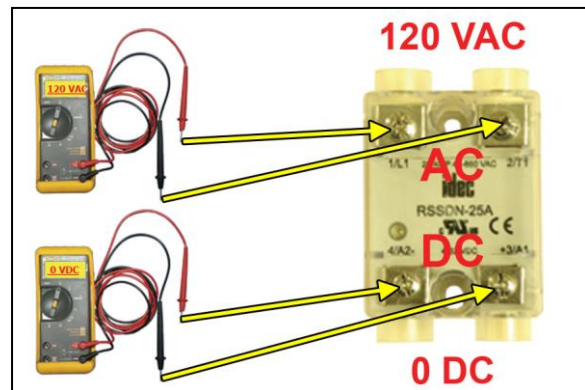

If any of the voltage measurements are different than indicated above, the Solid State Relay is defective and should be replaced. See sections 11.2 for part detail and 11.8 for ordering information.

9.6 Testing Consistent Heatless Dryer Cycling

With the Compressor running:

9.6.1 Open Front Door (section 8.4.1).

9.6.2 Open Front Panel (section 8.4.2).

9.6.3 Locate the Heatless Dryer and remove Mufflers.

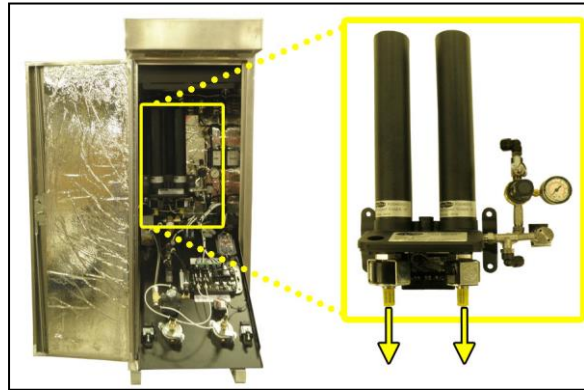

9.6.4 Place your hand beneath the purge fittings to feel for purging air. Air should:

- Purge from Tower 1 side
30 Seconds later
- Purge from Tower 2 side
30 Seconds later
- Purge from Tower 1 side
30 Seconds later
- ...and so on.

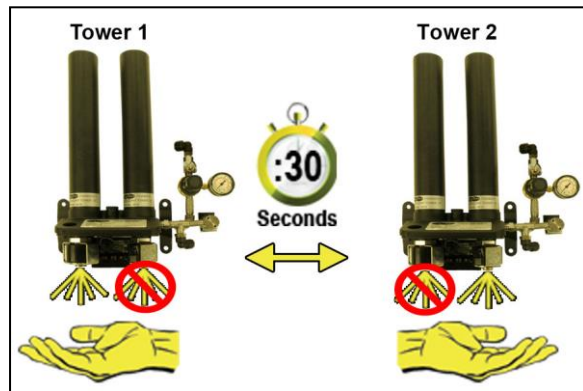

9.6.5 Re-install the purge mufflers.

9.6.6 Close Front Panel.

9.6.7 Close Front Door.

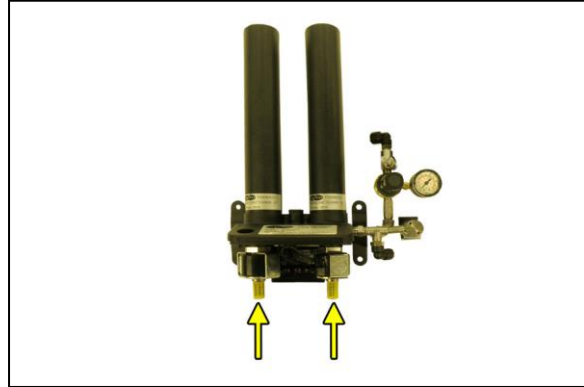

If the Heatless Dryer is not cycling consistently as described, see section 13.8 for troubleshooting information.

9.7 Testing Unloader Valve

With the Compressor running:

9.7.1 Open Front Door (section 8.4.1).

9.7.2 Open Front Panel (section 8.4.2).

9.7.3 Locate the Unloader Valve
and remove the muffler

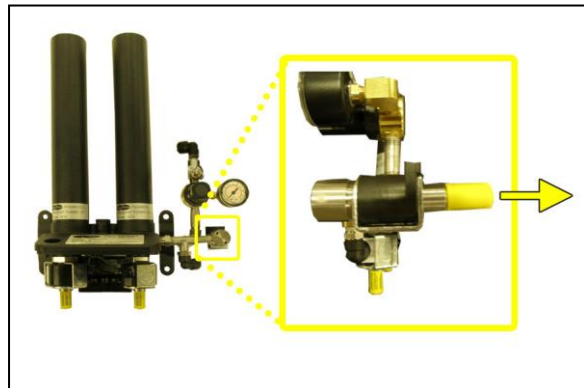

9.7.4 Place your hand behind the Unloader Valve fitting to feel for air flow.

Air should **NOT** flow from this fitting continuously. Air should only be released in a short burst when the compressor shuts off.



9.7.5 Re-install the muffler to the Unloader Valve.

9.7.6 Close Front Panel.

9.7.7 Close Front Door.

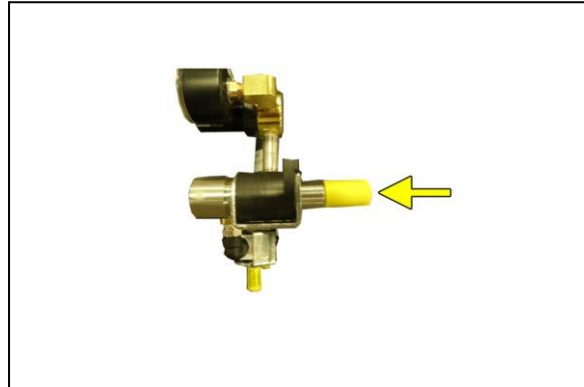

If air flows from this valve continuously the Unloader Valve is defective and should be replaced. See sections 11.3 for part detail and 11.8 for ordering information.

9.8 Measuring Heatless Dryer Solenoid Voltage

With the Compressor running:

9.8.1 Open Front Door (section 8.4.1).

9.8.2 Open Front Panel (section 8.4.2).

9.8.3 Locate the Heatless Dryer Cycle Timer.

The timer has three (3) sets of terminals (from left-to-right):
 “53VDC” – Left solenoid
 “IN” – Incoming power
 “53VDC” – Right solenoid

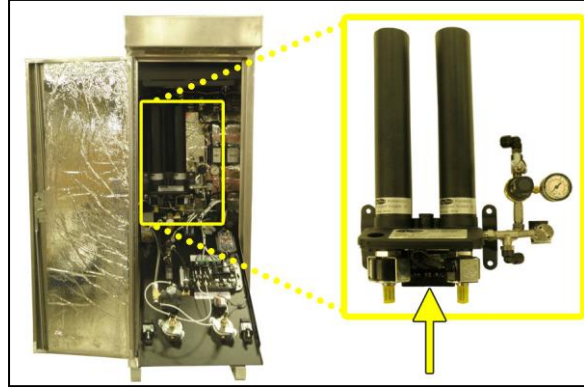

9.8.4 Use a Voltmeter to measure the DC voltage across each set of “53VDC” terminals.

Continue to measure for up to 45 seconds if no voltage is initially measured.

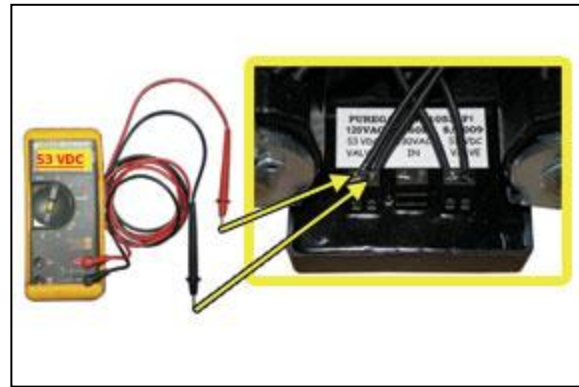

The voltage should measure **53 Volts DC**.

9.8.5 Close Front Panel.

9.8.6 Close Front Door.

If the voltage does not measure 53 Volts DC, this is an indication that the Cycle Timer is defective and should be replaced. See sections 11.3 for part detail and 11.8 for ordering information.

9.9 Testing Fan

NOTE: To test the fan, the cabinet temperature must be above 85°F.

9.9.1 Open Front Door (section 8.4.1).

9.9.2 Open Front Panel (section 8.4.2).

9.9.3 Place your hand below the Fan to feel for air being blown downwards into the cabinet.

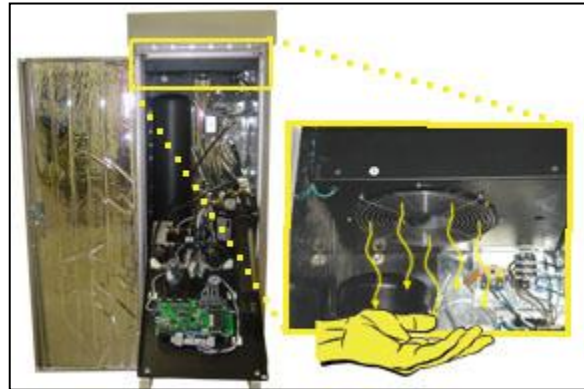

9.9.4 Close Front Panel.

9.9.5 Close Front Door.

If the fan is not blowing air downwards as described:

- *Check for loose wiring. Refer to the Wiring Diagram (section 14.1)*
- *Replace defective fan (see sections 11.1 for part detail and 11.8 for ordering information).*

9.10 Testing Cabinet Heater

NOTE: To test the heater, the cabinet temperature must be below 40°F.

9.10.1 Open Front Door (section 8.4.1).

9.10.2 Power the air dryer **OFF** (section 8.3).

9.10.3 Depressurize the air dryer (section 8.4).

9.10.4 Slide out Compressor Tray (section 8.5).

9.10.5 Locate the power lead wires to the Heater. Wire #s 9 & 21.

9.10.6 Power the air dryer **ON** (section 8.3).



9.10.7 Use a Voltmeter to measure the voltage:

9.10.7.1 Probe the terminal connections on the heater sensor.

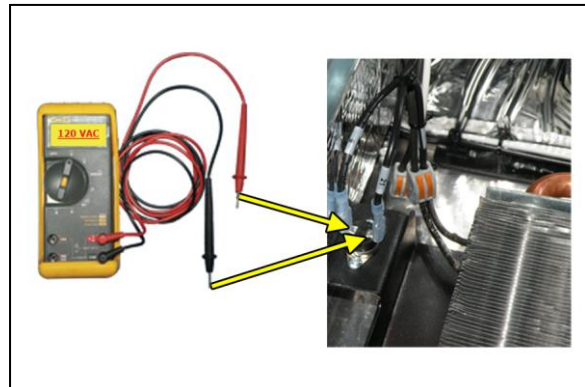

The voltage should measure **110 - 125 VAC**.

9.10.8 Power the air dryer **OFF** (section 8.3).

9.10.9 Slide in Compressor Tray.

9.10.10 Power the air dryer **ON** (section 8.3).

9.10.11 Close Front Door.

9.11 Testing Compressor ON/OFF Cycling

9.11.1 Open Front Door (section 8.4.1).

9.11.2 Locate the Tank Pressure Gauge.



With Compressor running:

9.11.3 Verify the compressor shuts down when the Tank Pressure Gauge reaches **50.0 PSI** (+/-3 PSI).



If the tank pressure gauge fails to reach 50 PSI (+/-3 PSI), see section 13.10 for troubleshooting information.

With Compressor NOT running:

9.11.4 Verify the compressor turns on when the Tank Pressure Gauge falls to **25.0 PSI** (+/-3 PSI).

9.11.5 Close Front Door.



If the Compressor Cycling fails either test described, it indicates a problem with the Control Board which may need to be replaced. See sections 11.2 for part detail and 11.8 for ordering information.

9.12 Testing Compressor Excessive Run Time Alarm

9.12.1 Open Front Door (section 8.4.1).

9.12.2 Open Front Panel (section 8.4.2).

9.12.3 Start timing when the compressor turns on.

9.12.4 Push the outlet tube in and hold the ferrule. While holding the ferrule pull the tube out until air pressure is released to keep the Tank Pressure Gauge from reaching **50 PSI**.

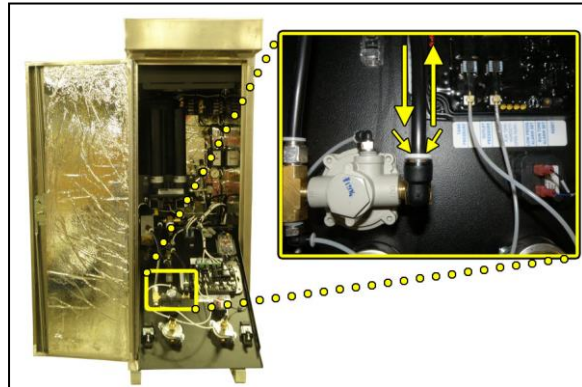

This prevents the compressor from shutting down.

9.12.5 After 3:00 minutes (unless adjusted to a different Set Point by the user), the Run Time Alarm LED should illuminate

9.12.6 Press the **RESET Button**.

9.12.7 Reconnect Outlet Tube.

9.12.8 Close Front Panel.

9.12.9 Close Front Door.

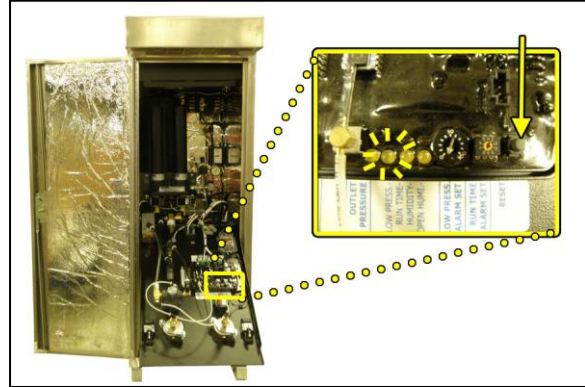

If you are unable to create a Compressor Excessive Run Time Alarm as described, see section 13.12 for troubleshooting information.

9.13 Testing Humidity Alarm and System Shutdown

9.13.1 Open Front Door (section 8.4.1).

9.13.2 Open Front Panel (section 8.4.2).

9.13.3 Push the outlet tube in and hold the ferrule. While holding the ferrule pull the tube out until air pressure is released.

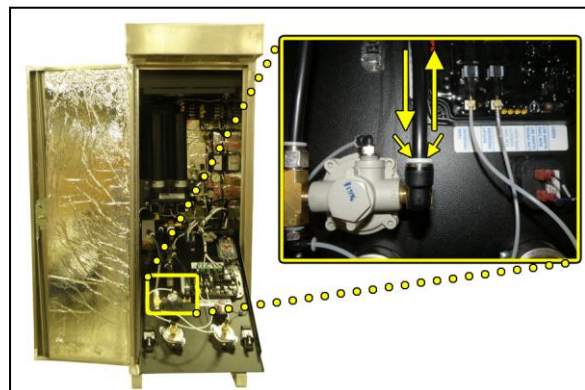

9.13.4 Unscrew and remove the Humidity Sensor from the Humidity Block.

9.13.5 Reinstall outlet tube.

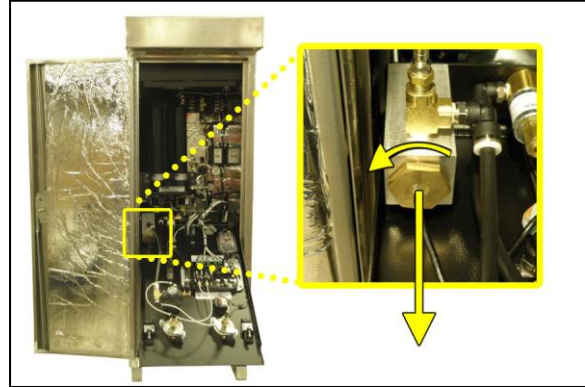

9.13.6 Green Humidity and Bypass Indicators will darken once the Humidity reading reaches 10.0% or higher.

9.13.7 Verify that the Humidity LED flashes

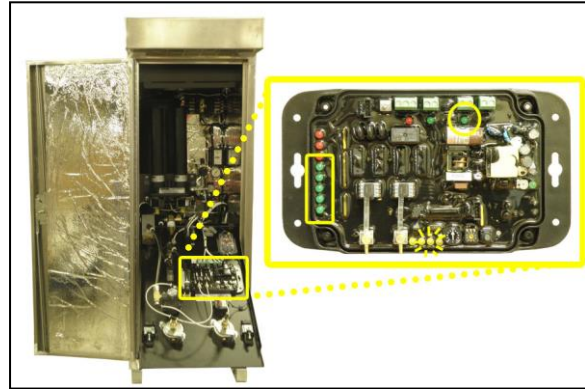

9.13.8 After 5 minutes the Humidity LED illuminates solid and the dryer goes into **SHUTDOWN** mode.

9.13.9 Replace the Humidity Sensor in the Humidity Block.

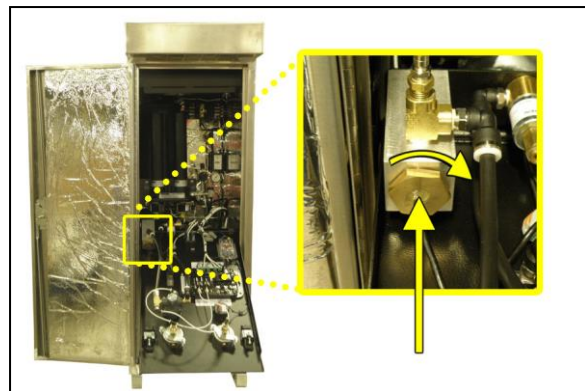

9.13.10 Press the **RESET Button** to clear the Humidity alarm.

9.13.11 Close Front Panel.

9.13.12 Close Front Door.

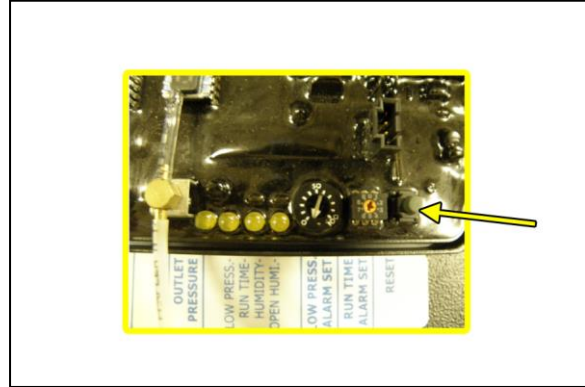

If you are unable to create a Humidity/Shutdown Alarm as described, see section 13.7 for troubleshooting information.

9.14 Testing Humidity Open Circuit, Bypass Valve, and Shutdown

9.14.1 Open Front Door (section 8.4.1).

9.14.2 Open Front Panel (section 8.4.2).

9.14.3 Disconnect the Humidity Sensor from the Control Board.

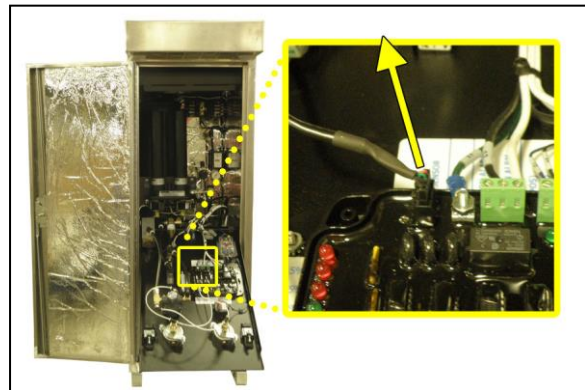

9.14.4 Humidity and Bypass

Indicators will darken.

9.14.5 Verify that the Open Humi

LED flashes and the Bypass Valve opens.

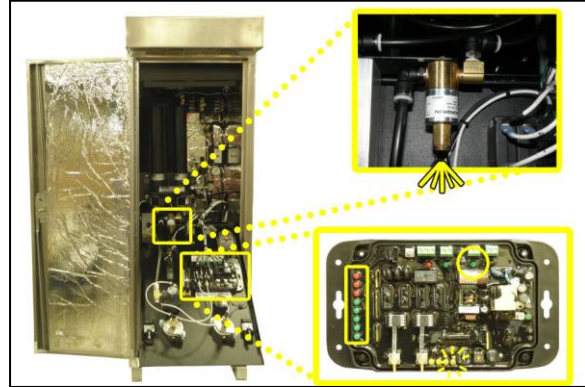

9.14.6 After 5 minutes the Open Humi LED illuminates solid and the dryer goes into **SHUTDOWN** mode.

9.14.7 Reconnect the Humidity Sensor.

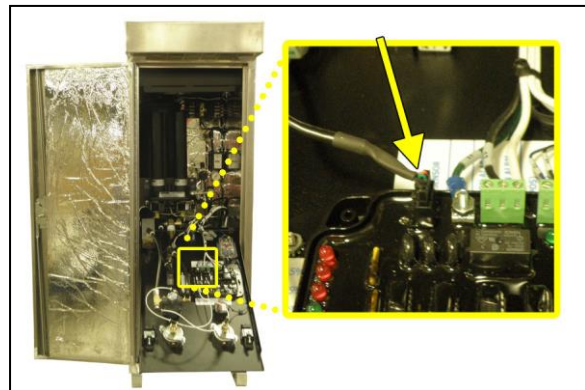

9.14.8 Press the **RESET Button** to clear the Humidity alarm.

9.14.9 Close Front Panel.

9.14.10 Close Front Door.



If you are unable to create an Open Circuit/Shutdown Alarm as described, see section 13.7 for troubleshooting information.

9.15 Testing Low Outlet Pressure Alarm

9.15.1 Open Front Door (section 8.4.1).

9.15.2 Make note of the current Outlet Pressure reading.



9.15.3 Loosen the Outlet Pressure Regulator Locknut.



9.15.4 Turn knob until Outlet Pressure reading is below 6.5 PSI (unless adjusted to a different Set Point by the user).

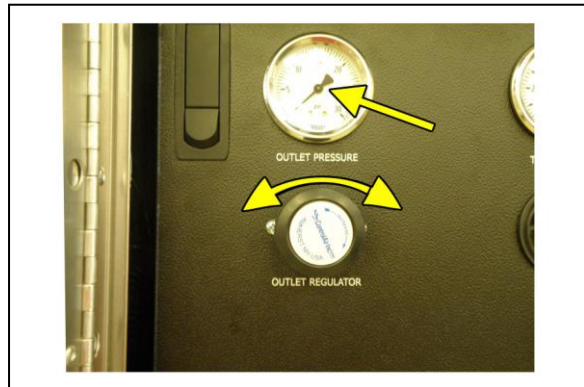

9.15.5 Lower the Front Panel (section 8.4.2).

9.15.6 Verify the Low Pressure LED flashes.

After 5 minutes the LED will illuminate solid indicating a latched alarm.

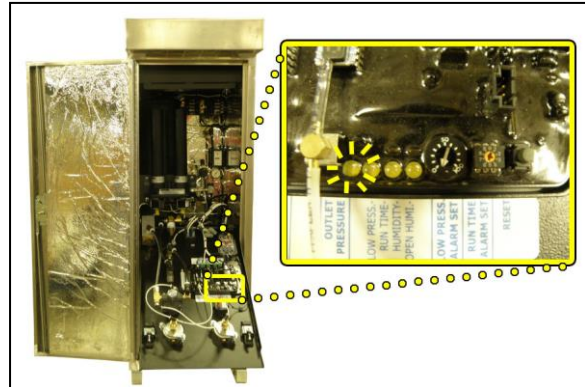

9.15.7 Press the **RESET Button** to clear the Humidity alarm.



9.15.8 Close and latch the Front Panel.

9.15.9 Set Outlet Pressure to desired normal setting. (Section 8.8).

9.15.10 Close the Front Door.

If you are unable to create a Low Outlet Pressure Alarm as described, see section 13.5 for troubleshooting information.

9.16 Testing Air Fittings & Hoses for Leaks

NOTE: This is a general procedure that can be applied to any fitting or hose that has air pressure in it. **DO NOT SOAP TEST THE HUMIDITY SENSOR. DAMAGE TO THE SENSOR MAY OCCUR.**

With Compressor NOT running:

9.16.1 Listen for any 'hissing' sounds which may indicate a fitting or hose air leak.

With Compressor running:

9.16.2 Use a 1-inch paint brush to dab soapy water on the air fitting or hose connection to be tested.

If air bubbles appear at the connection, this indicates that air is leaking from the connection.



If any leaks are detected, take steps to seal them off (as necessary):

- *Tighten the fitting*
- *Re-connect the hose end*
- *Replace the fitting/hose/component*

10. Maintaining Your Dryer

In order to ensure that your P4200PM / P5000PM Air Dryer continues to operate efficiently and reliably, ALTEC AIR recommends performing the following maintenance procedures at the specified Six Month intervals.

It is also recommended that you print out the included *6 Month Maintenance (section 10.2)* log sheet and record all completed maintenance for historical tracking and reference purposes.

The log sheet includes a Section reference column which indicates the User's Guide section containing the information about the specific procedure. Please refer to these sections for detailed procedural information.

NOTE: When operating at higher ambient temperatures, it is recommended that maintenance be performed more frequently.

NOTE: After 16,000 hours of run time, ALTEC AIR recommends sending in your compressors and heatless dryers for a complete and comprehensive rebuild by our Service Department technicians. *See sections 12.1 and 12.2 for information on services and contacting ALTEC AIR.*

10.1 Safety & Warning Information



WARNING!

Extreme care should be exercised to avoid contact with live electrical circuits. Many procedures performed during installation, operation, testing, and maintenance of this air dryer require the equipment to be running, creating a situation for potential electrical shock. It is highly recommended that you remove all jewelry before performing any procedures.

**WARNING!**

Internal surfaces may be hot. Use care when coming into contact with internal components as there is a potential for some of these components to become hot when in operation or standby.

**CAUTION!**

SHUT DOWN IMMEDIATELY FOR REPAIRS if the air compressor shows any evidence of overheating or presents excessive noise.

**CAUTION!**

Depressurizing the air dryer may be necessary before performing certain procedures. **NEVER** remove pressure sensing tubes from the Control Board without depressurizing the air dryer first, or **damage to the Control Board will occur.**

**IMPORTANT!**

Performing routine maintenance as outlined in the *Maintaining Your Dryer* section will ensure optimal performance over the lifecycle of your air dryer.

**IMPORTANT!**

Performing procedures not described in this User's Guide or installing components not supplied by PUREGAS is **NOT RECOMMENDED AND MAY VOID THE WARRANTY.**

**IMPORTANT!**

After performing any maintenance, always soap test pressure fittings to check for air leaks. Also, check for any loose or disconnected wiring.

10.2 Six Month Maintenance

MODEL: **P4200PM / P5000PM** LOCATION NAME: _____

SERIAL NUMBER: _____ ADDRESS: _____

DATE INSTALLED: _____

Procedure	Section	Maintenance Interval (Months)				
		6	12	18	24	30
Install 6 Month Maintenance Kit P4200PM - P012907 P5000PM - P012879 (Type A) 100520092 (Type B)	11.7	<input type="checkbox"/>	<input type="checkbox"/>	<input type="checkbox"/>	<input type="checkbox"/>	<input type="checkbox"/>
Install Compressor Maintenance Kit P4200PM - P010491 P5000PM - P3865	11.7		<input type="checkbox"/>		<input type="checkbox"/>	
Install Heatless Dryer Maintenance Kit P200499S	11.7				<input type="checkbox"/>	
Read & Record Flow Rate (FLOW)	11.1					
Measure & Record Compressor Amp Draw	9.2					
Measure & Record Incoming Voltage (must be 110-125 VAC)	9.4					
Test Low Outlet Pressure Alarm	9.15	<input type="checkbox"/>	<input type="checkbox"/>	<input type="checkbox"/>	<input type="checkbox"/>	<input type="checkbox"/>
Set System Pressure (50 PSI)	8.7	<input type="checkbox"/>	<input type="checkbox"/>	<input type="checkbox"/>	<input type="checkbox"/>	<input type="checkbox"/>
Set Outlet Pressure	8.8	<input type="checkbox"/>	<input type="checkbox"/>	<input type="checkbox"/>	<input type="checkbox"/>	<input type="checkbox"/>
Test Consistent Heatless Dryer Cycling	9.6	<input type="checkbox"/>	<input type="checkbox"/>	<input type="checkbox"/>	<input type="checkbox"/>	<input type="checkbox"/>
Test Fan	9.9	<input type="checkbox"/>	<input type="checkbox"/>	<input type="checkbox"/>	<input type="checkbox"/>	<input type="checkbox"/>
Test Cabinet Heater	9.10	<input type="checkbox"/>	<input type="checkbox"/>	<input type="checkbox"/>	<input type="checkbox"/>	<input type="checkbox"/>
Test Compressor ON/OFF Cycling	9.11	<input type="checkbox"/>	<input type="checkbox"/>	<input type="checkbox"/>	<input type="checkbox"/>	<input type="checkbox"/>
Test Compressor Excessive Run Time Alarm	9.12	<input type="checkbox"/>	<input type="checkbox"/>	<input type="checkbox"/>	<input type="checkbox"/>	<input type="checkbox"/>
Test Humidity Alarm & System Shutdown	9.13& 9.14	<input type="checkbox"/>	<input type="checkbox"/>	<input type="checkbox"/>	<input type="checkbox"/>	<input type="checkbox"/>
Test Air Fittings for Leaks	9.16	<input type="checkbox"/>	<input type="checkbox"/>	<input type="checkbox"/>	<input type="checkbox"/>	<input type="checkbox"/>
Clean Precooler Coils	11.5	<input type="checkbox"/>	<input type="checkbox"/>	<input type="checkbox"/>	<input type="checkbox"/>	
Visually Inspect Inside & Outside of Unit for Loose Wiring or Hardware	6.5.3	<input type="checkbox"/>	<input type="checkbox"/>	<input type="checkbox"/>	<input type="checkbox"/>	<input type="checkbox"/>
Maintenance Performed by:						
Date of Maintenance:						

NOTE: COPY OR PRINT THIS PAGE AND KEEP IT WITH THE AIR DRYER

11. Replacement Parts & Accessories

11.1 Upper Section Parts

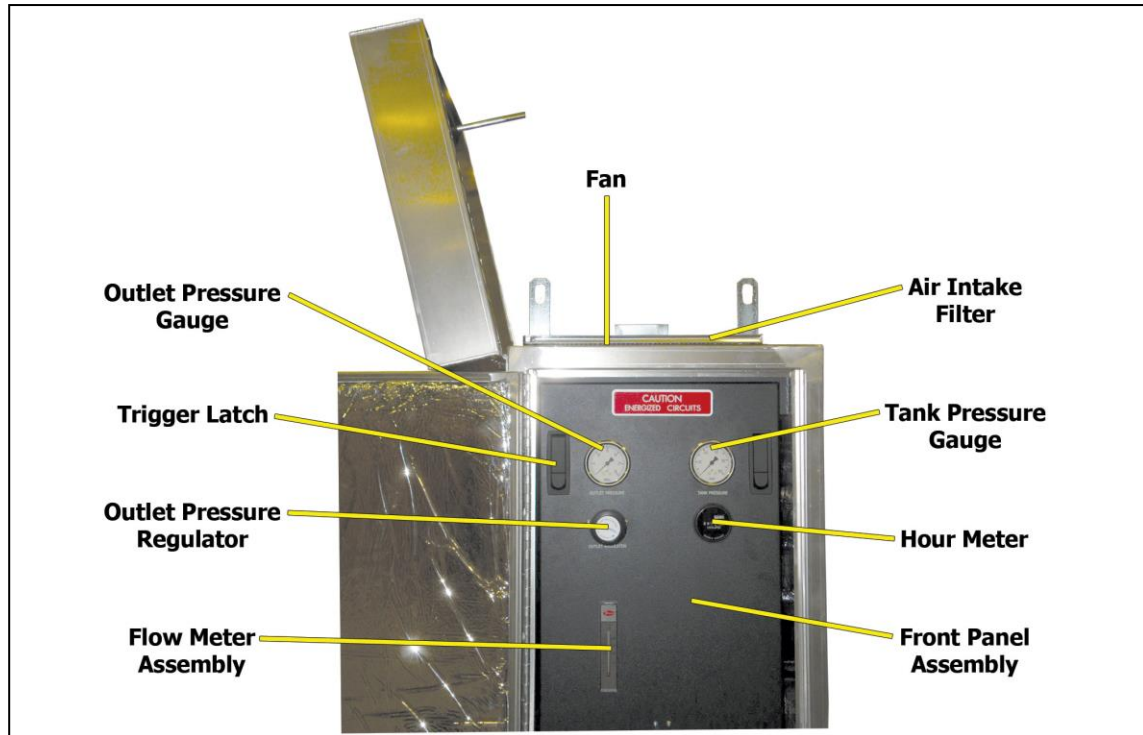

Description	Part Number	Quantity	Recommend Spare
Outlet Pressure Gauge	<i>See section 11.2 for detail.</i>		
Trigger Latch	<i>See section 11.2 for detail.</i>		
Outlet Pressure Regulator	<i>See section 11.2 for detail.</i>		
Flow Meter Assembly	<i>See section 11.2 for detail.</i>		
Fan	P012666	1	✓ (1)
Air Intake Filter	P15186	<i>In Maintenance Kits P012907 & P012879. See Section 11.7 for detail.</i>	
Tank Pressure Gauge	<i>See section 11.2 for detail.</i>		
Hour Meter	<i>See section 11.2 for detail.</i>		
Front Panel Assembly	P012589	<i>See section 11.2 for detail.</i>	

11.2 Front Panel Assembly Parts

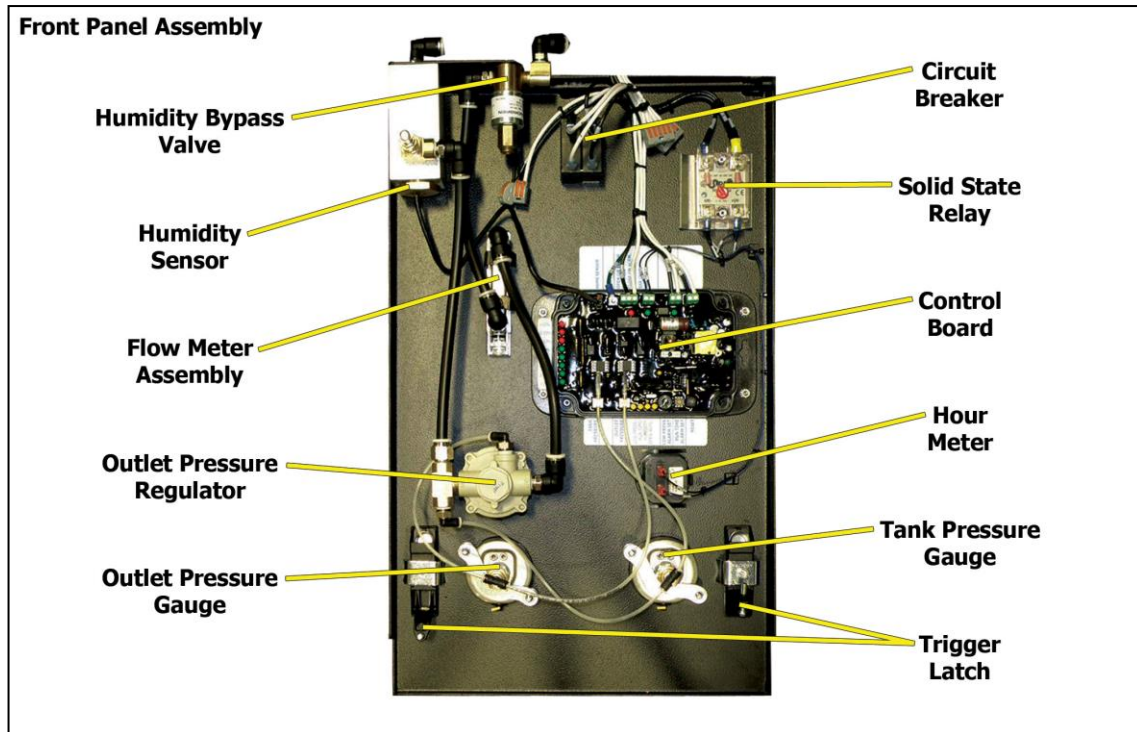

Description	Part Number	Quantity	Recommend Spare
Front Panel Assembly	P012589	1	
Humidity Bypass Valve	P012663	1	✓ (1)
Humidity Sensor	P011380	1	✓ (1)
Flow Meter Assembly	P012778	1	
Outlet Pressure Regulator	P012779	1	✓ (1)
Outlet Pressure Gauge	P012781	1	
Circuit Breaker	P06138	1	✓ (1)
Solid State Relay	P013159	1	✓ (1)
Control Board	P012591	1	✓ (1)
Hour Meter	P012590	1	
Tank Pressure Gauge	P012780	1	
Trigger Latch	P08947F1	2	

11.3 Internal Cabinet Parts

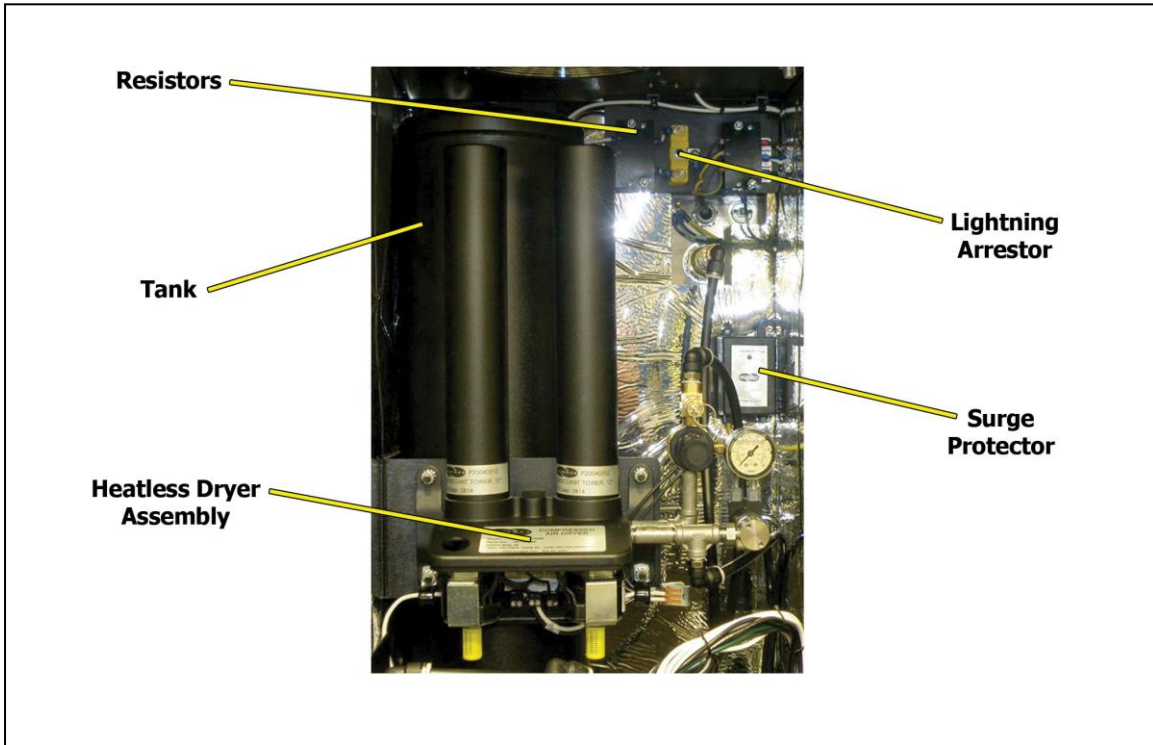

Description	Part Number	Quantity	Recommend Spare
Resistors (270K)	B142	2	
Tank		1	
Heatless Dryer Assembly - P4200PM P5000PM	P012831 P012608	<i>See Section 11.4 for detail.</i>	
Lightning Arrester	P011788	1	
Surge Protector	P011835	1	

11.4 Heatless Dryer Assembly Parts

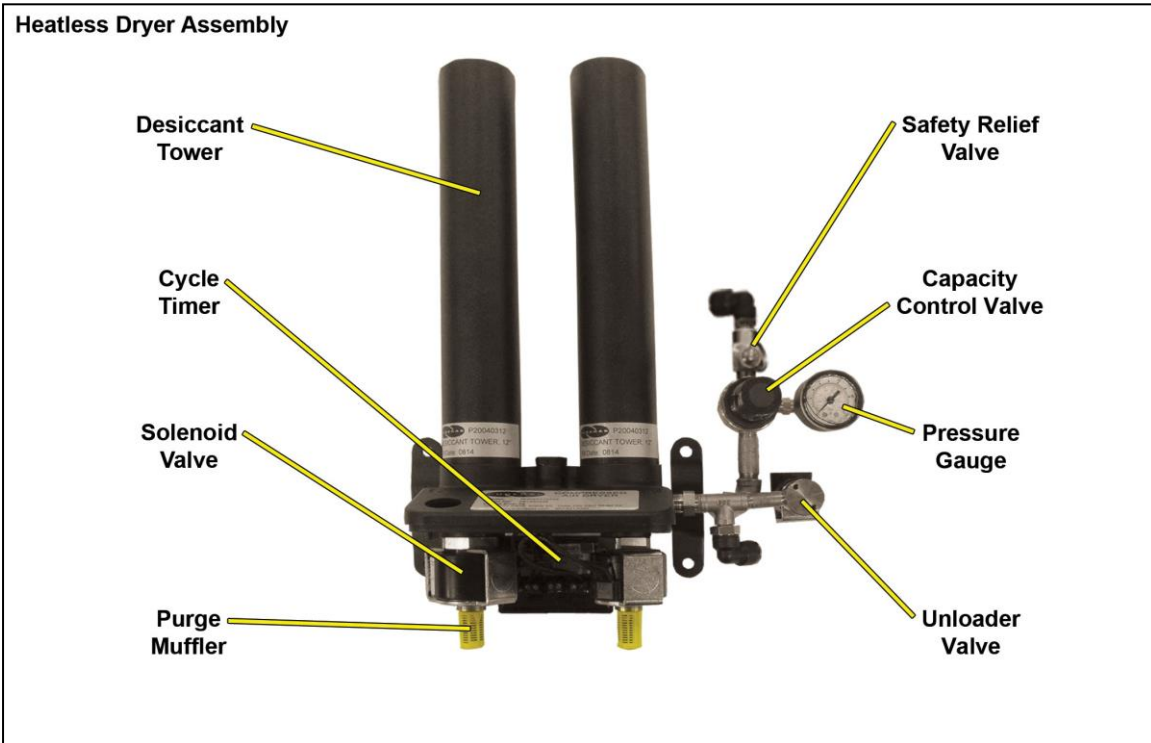

Description	Part Number	Quantity	Recommend Spare
Heatless Dryer Assembly -			
P4200PM	P012831	1	
P5000PM	P012608		
Desiccant Tower	P20040312	2	✓ (2)
Cycle Timer	P010530F1	1	
Solenoid Valve	<i>In Kit P200499S. See Section 11.7 for detail.</i>		
Purge Muffler	10040	<i>In Maintenance Kits P012907 & P012879. See Section 11.7 for detail.</i>	
Safety Relief Valve	P03646	1	
Capacity Control Valve	P4634	1	✓ (1)
Pressure Gauge (0-100 PSI)	P010695	1	
Unloader Valve	P011022	1	✓ (1)

11.5 Lower Section Parts

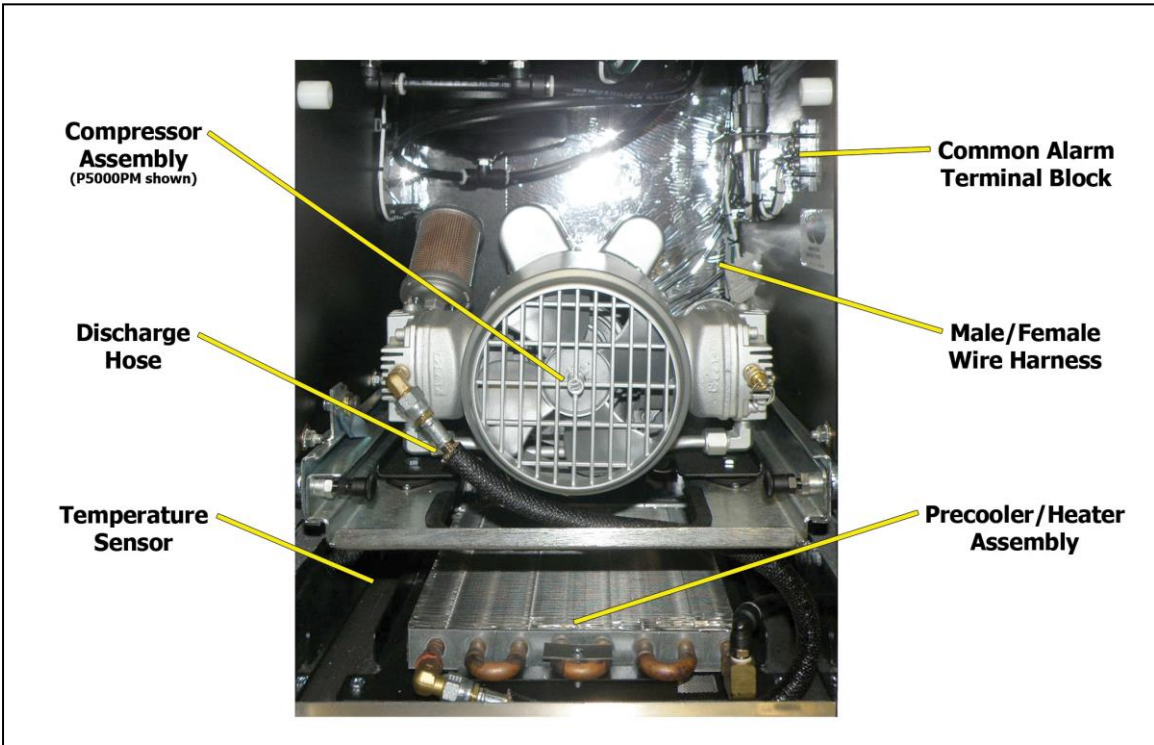





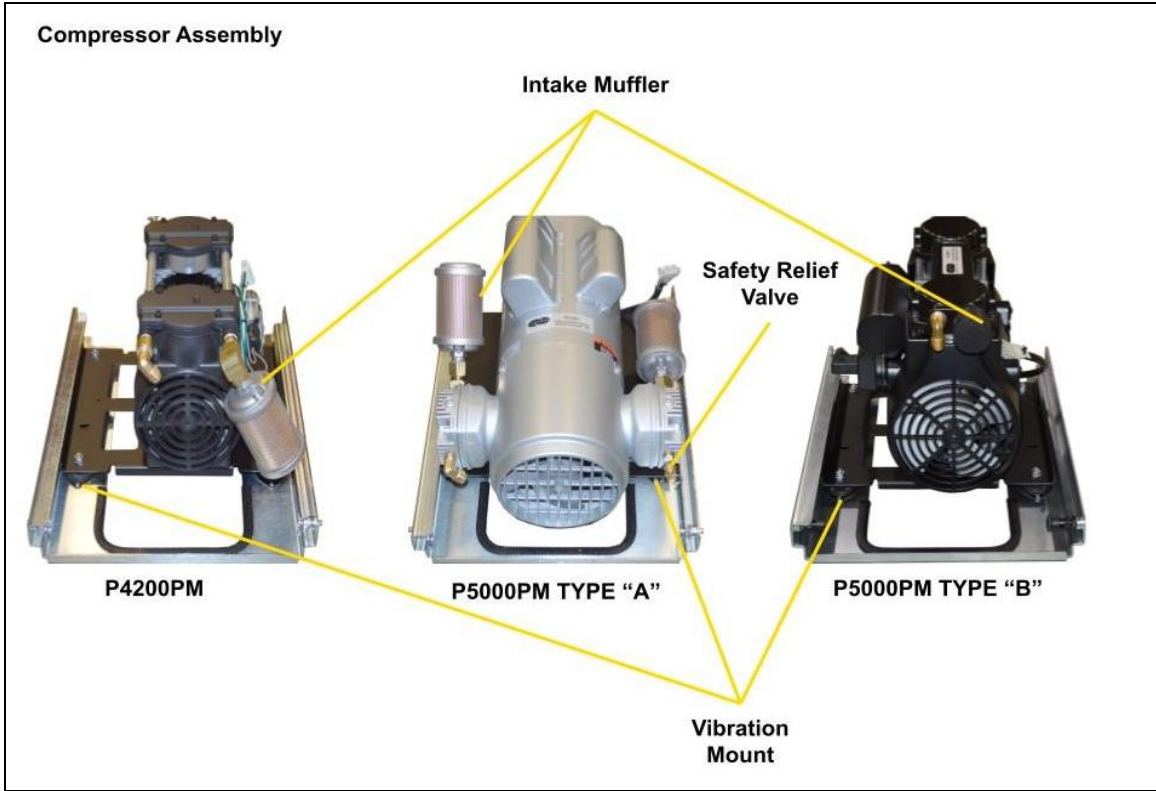

Description	Part Number	Quantity	Recommend Spare
Compressor Assembly - P4200PM P5000PM	P012829 P012617	<i>See Section 11.6 for detail.</i>	
Discharge Hose	P05069	1	
Temperature Sensor	8298	1	
Common Alarm Terminal Block		1	
Wire Harness – Male Female	P011283 P011284	1 1	
Precooler / Heater Assembly	P012609	1	

11.6 Compressor Assembly Parts



Description		Part Number	Quantity	Recommend Spare
Intake Muffler		P010192		<i>In Maintenance Kits P012907 & P012879. See Section 11.7 for detail.</i>
Intake Muffler Type "B" P5000PM		100519602		
Safety Relief Valve		P3996	1	
Vibration Mount –	P4200PM	P02626S	4	
	P5000PM	P02626S-16		

11.7 Accessories for Your Dryer

	Description	Part Number	Recommend Spare
	P4200PM Six Month Maintenance Kit Includes air intake filter, compressor mufflers, and purge mufflers.	P012907	✓ (2)
	P5000PM Six Month Maintenance Kit Includes air intake filter, compressor mufflers, and purge mufflers.	P012879 Type "A" 100520092 Type "B" See type below	✓ (2)
	P4200PM Compressor Maintenance Kit Includes all necessary parts to repair compressor.	P010491	✓ (1)
	P5000PM Compressor Maintenance Kit Includes all necessary parts to repair compressor.	P3865 Type "A" See type below	✓ (1)
	P5000PM Compressor Maintenance Kit Includes all necessary parts to repair compressor.	100519604 Type "B" See type below	✓ (1)
	Heatless Dryer Maintenance Kit Includes all necessary parts to repair heatless dryer.	P200499S	✓ (1)
	Air Tank Tube Replacement Kit Includes all necessary parts to replace tubes from the air tank.	100520481 Type "B" See type below	✓ (1)

P5000PM TYPE "A" COMPRESSOR

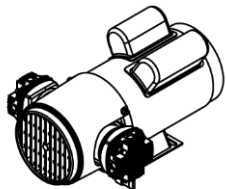

P5000PM TYPE "B" COMPRESSOR

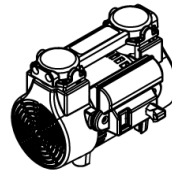

11.8 Ordering Parts from ALTEC AIR



IMPORTANT!

Instruction for the replacement of individual listed components goes beyond the scope of this User's Guide and will not be covered. Please refer to the information included with the specific replacement part for this instruction.

Once you have identified your required parts and accessories, contact the ALTEC AIR Inside Sales / Service department to order:

(800) 521-5351 (**option 2**)

Fax – (303) 657-2205

sales@AltecAIR.com

parts@AltecAIR.com

12. Service & Repair

Only ALTEC AIR can offer factory direct rebuilds backed by a 6 month factory warranty.

- 2 week turnaround time
- Estimates available upon request
- Minimum service charge fee applies

12.1 Services Offered

- **Piston Compressor Rebuild**
 - Replace motor bearings, piston rod assemblies, and install a complete compressor maintenance kit.
 - Test air flow, air pressure, and electrical performance
- **Heatless Dryer Rebuild**
 - Replace desiccant, o-rings, check valves, springs, and complete solenoid assembly
 - Test proper component operation
- **Desiccant Tower Repack**
 - Clean out tower and replace desiccant, filter, and o-ring
- **Circuit Board Repair** (Limited to current model boards only)
- **Complete Dryer Repair**

12.2 Initiating a Service Transaction

- Contact our Parts & Service Department at **1-800-521-5351 (option 3)** to obtain a Return Authorization (RA) number.
- Carefully package the item(s) to be returned.
- Mark the Return Authorization (RA) number on the outside of the shipping container.
- Include the main address and phone number of the individual to contact for related inquiry and follow-up information.
- Include the purchase order number.

13. Troubleshooting Your Dryer

13.1 Before You Call ALTEC AIR

PLEASE READ THIS SECTION FIRST. It is important that you use the following sections in order to diagnose and attempt to fix the problem with your air dryer before placing a call to ALTEC AIR Technical Support.

This troubleshooting guide is intended to simplify the isolation of problems, present possible causes, provide test procedures for verification, and suggest corrective actions to restore the air dryer back to normal operation. Each section begins with the most likely cause(s) of the issue. Otherwise, they start from the simplest possibilities and progress to more complicated ones.

This troubleshooting guide is designed to be easy to follow and very effective when used properly. It is suggested to always start at the beginning of the specific problem section and continue in sequence, following the procedures indicated.

13.2 Safety & Warning Information



WARNING!

For your safety, all the information in this User's Guide must be followed to minimize the risk of electrical shock, and prevent property damage or personal injury.



WARNING!

Internal surfaces may be hot. Use care when coming into contact with internal components as there is a potential for some of these components to become hot when in operation or standby.

**WARNING!**

Extreme care should be exercised to avoid contact with live electrical circuits. Many procedures performed during installation, operation, testing, and maintenance of this air dryer require the equipment to be running, creating a situation for potential electrical shock. It is highly recommended that you remove all jewelry before performing any procedures.

**CAUTION!**

Depressurizing the air dryer may be necessary before performing certain procedures. **NEVER** remove pressure sensing tubes from the Control Board without depressurizing the air dryer first, or **damage to the Control Board will occur.**

**CAUTION!**

Do not test the Humitter with an ohm meter or apply any DC voltage. This will render the Humitter defective.

**IMPORTANT!**

Performing procedures not described in this User's Guide or installing components not supplied by PUREGAS is **NOT RECOMMENDED AND MAY VOID THE WARRANTY.**

**CAUTION!**

Observe precautions for handling **Electrostatic Sensitive Devices.**

13.3 Air Dryer Won't Power ON

Possible Cause	Check	Corrective Action
POWER Circuit Breaker in OFF position	Verify POWER Circuit Breaker is in ON position (section 8.3)	Move POWER Circuit Breaker to ON position (section 8.3)
No incoming voltage to air dryer	Measure incoming voltage (section 9.4)	Troubleshoot facility power supply to air dryer

13.4 Low Outlet Pressure Alarm

Possible Cause	Check	Corrective Action
Outlet Pressure set too low	Verify Outlet Pressure reading (section 8.8)	Adjust Outlet Pressure Regulator (section 8.8)
High Flow condition	Verify Flow Rate reading is not higher than expected	Locate source of external leak or restriction and repair.
Low Outlet Pressure Alarm set point too high	Verify Low Outlet Pressure Alarm set point (section 8.10)	Lower the Low Outlet Pressure Alarm set point (section 8.10)

13.5 Can't Create a Low Pressure Alarm

Possible Cause	Check	Corrective Action
Defective Outlet Pressure Regulator	Verify that the Outlet Pressure Regulator can be adjusted (section 8.8)	Replace Outlet Pressure Regulator if unable to adjust pressure (section 11.1)
Low Outlet Pressure Alarm set point lower than default setting of 6.5 PSI	Verify Low Outlet Pressure Alarm set point (section 8.10)	Adjust Outlet Pressure Regulator so that Outlet Pressure reading drops below verified set point (section 8.8)
Defective Control Board	Verify that the Outlet Pressure reading is lower than the Low Outlet Pressure Alarm set point (above)	Replace Control Board (section 11.2) if Outlet Pressure reading is under verified Low Outlet Pressure Alarm set point for more than 5 minutes and fails to create an alarm.

13.6 High Humidity



CAUTION!

Do not test the Humidity sensor with an ohm meter or apply any DC voltage. This will render the Humidity Sensor defective.

Possible Cause	Check	Corrective Action
Low System Pressure	Verify System Pressure (section 8.7)	Adjust System Pressure to 50 PSI (section 8.7)
Low Flow Rate	Verify Flow Rate reading is low	Increase flow by creating an artificial leak outside of the air dryer
Defective Humidity Sensor	Perform the Testing Humidity Alarm and System Shutdown test (section 9.13)	Troubleshoot <i>Can't Create a High Humidity Alarm / Shutdown</i> condition (section 13.7)
Heatless Dryer not cycling between towers	Verify consistent Heatless Dryer cycling (section 9.6)	Troubleshoot <i>Inconsistent Heatless Dryer Cycling</i> condition (section 13.8)
Defective Control Board	Unplug Humidity Sensor from Control Board (see section 9.14) Humidity Indicators should darken	If Humidity Indicators did not darken, replace Control Board (section 11.2)

13.7 Can't Create a High Humidity Alarm / Shutdown

These troubleshooting steps assume that the Humidity Sensor is removed from the Humidity Block during the *Testing Humidity Alarm and System Shutdown* (section 9.13) procedures.

Possible Cause	Check	Corrective Action
Defective Humidity Sensor	Verify that Humidity reading fails to climb higher than 15% or creates sporadic readings	Replace Humidity Sensor (section 11.2)
Defective Control Board	Verify that Humidity reading is over 15% for more than 5 minutes	Replace Control Board if no alarm is created and system does not shut down (section 11.2)

13.8 Inconsistent Heatless Dryer Cycling

Possible Cause	Check	Corrective Action
Defective Solenoid Valve	Measure voltage going to the Heatless Dryer Solenoid Valves (section 9.8)	If 53 VDC IS present, replace Solenoid Valves included in the Maintenance Kit (section 11.4)
Defective Cycle Timer	Measure voltage going to the Heatless Dryer Solenoid Valves (section 9.8)	If 53 VDC IS NOT present, replace the Cycle Timer (section 11.4)

13.9 Compressor Doesn't Operate

Possible Cause	Check	Corrective Action
Defective compressor	Measure voltage to compressor (section 9.3)	If voltage is good, replace compressor (section 11.6) or send it in for repair (section 12.)
No power to compressor	Measure voltage to compressor (section 9.3)	If voltage is NOT present or fluctuates, continue to next Possible Cause
Defective Solid State Relay	Measure voltages at Solid State Relay (section 9.5)	If measurements are bad, replace Solid State Relay (section 11.2)
System is in Shutdown state	Verify unit is not in a Humidity alarm (section 8.9)	Press the RESET Button (section 8.9)

13.10 Compressor Won't Build Pressure

Possible Cause	Check	Corrective Action
Low System Pressure	Verify System Pressure (section 8.7)	Adjust System Pressure to 50 PSI (section 8.7)
Defective Unloader Valve	Test Unloader Valve operation (section 9.7) If this is continuously flowing high amounts of air, the Unloader Valve is defective.	Replace Unloader Valve (section 11.4)
Leak in air system	Check all hoses and fittings between compressor and Air Tank for air leaks (section 9.16)	Connect, tighten, or replace leaking component

13.11 Compressor Excessive AMP Draw

Possible Cause	Check	Corrective Action
Restriction in air line	Remove Discharge Hose from compressor (see section 11.5 for location of hose) Re-measure Compressor AMP Draw (section 9.2)	If measurement is below 11.0 amps, trace hoses from compressor to Unloader Valve looking for restrictions or kinks
Compressor failing	Remove Discharge Hose from compressor (see section 11.5 for location of hose) Re-measure Compressor AMP Draw (section 9.2)	If measurement is still above 11.0 amps, replace compressor (section 11.6) or send it in for repair (section 12.)

13.12 Compressor Excessive Run Time Alarm

Possible Cause	Check	Corrective Action
Low System Pressure	Verify System Pressure (section 8.7)	Adjust System Pressure to 50 PSI (section 8.7)
High Flow condition	Verify Flow Rate reading is not higher than expected	Troubleshoot High Flow condition
Defective Unloader Valve	Test Unloader Valve operation (section 9.7) If this is continuously flowing high amounts of air, the Unloader Valve is defective.	Replace Unloader Valve (section 11.4)
Defective Heatless Dryer Solenoid Valve	Verify consistent Heatless Dryer cycling (section 9.6) If either side is continuously flowing high amounts of air, the Solenoid Valve is defective.	Replace Solenoid Valves included in the Maintenance Kit (section 11.4)
Defective Solid State Relay	Measure voltages at Solid State Relay (section 9.5)	If measurements are bad, replace Solid State Relay (section 11.2)

13.13 Can't Create a Compressor Excessive Run Time Alarm

Possible Cause	Check	Corrective Action
Compressor Excessive Run Time Alarm set point higher than the default of 3:00 minutes	Verify Excessive Compressor Run Time Alarm set point (section 8.11)	Allow the compressor to run longer than the verified set point (section 9.12)
Defective Control Board	Verify that the compressor has run longer than the verified Excessive Compressor Run Time Alarm set point (above)	Replace Control Board (section 11.2) if the compressor runs longer than the verified Excessive Compressor Run Time Alarm set point by 1 minute or more and fails to create an alarm.

13.14 Compressor Rapid ON/OFF Cycling

Possible Cause	Check	Corrective Action
Defective Solid State Relay	Measure voltages at Solid State Relay (section 9.5)	If measurements are bad, replace Solid State Relay (section 11.2)
Defective Control Board	Measure voltages at Solid State Relay (section 9.5)	If measurements are good, replace Control Board (section 11.2)

13.15 Contacting ALTEC AIR Technical Support

Please read the *Before You Call ALTEC AIR* section (13.1)

Once you have exhausted all of the potential problems and solutions covered in the *Troubleshooting Your Dryer* section, and you still require further assistance to correct a problem, contact ALTEC AIR Technical Support:

(800) 521-5351 (option 1)

Have the following information available:

Trouble Ticket # (if following-up on a previous call): _____

Technician Name: _____ **Phone #:** _____

Model #: **P4200PM / P5000PM** _____ **Serial #:** _____

Company Name: _____ **Location Name:** _____

City: _____ **State:** _____

14. Appendix

14.1 Wiring Diagram

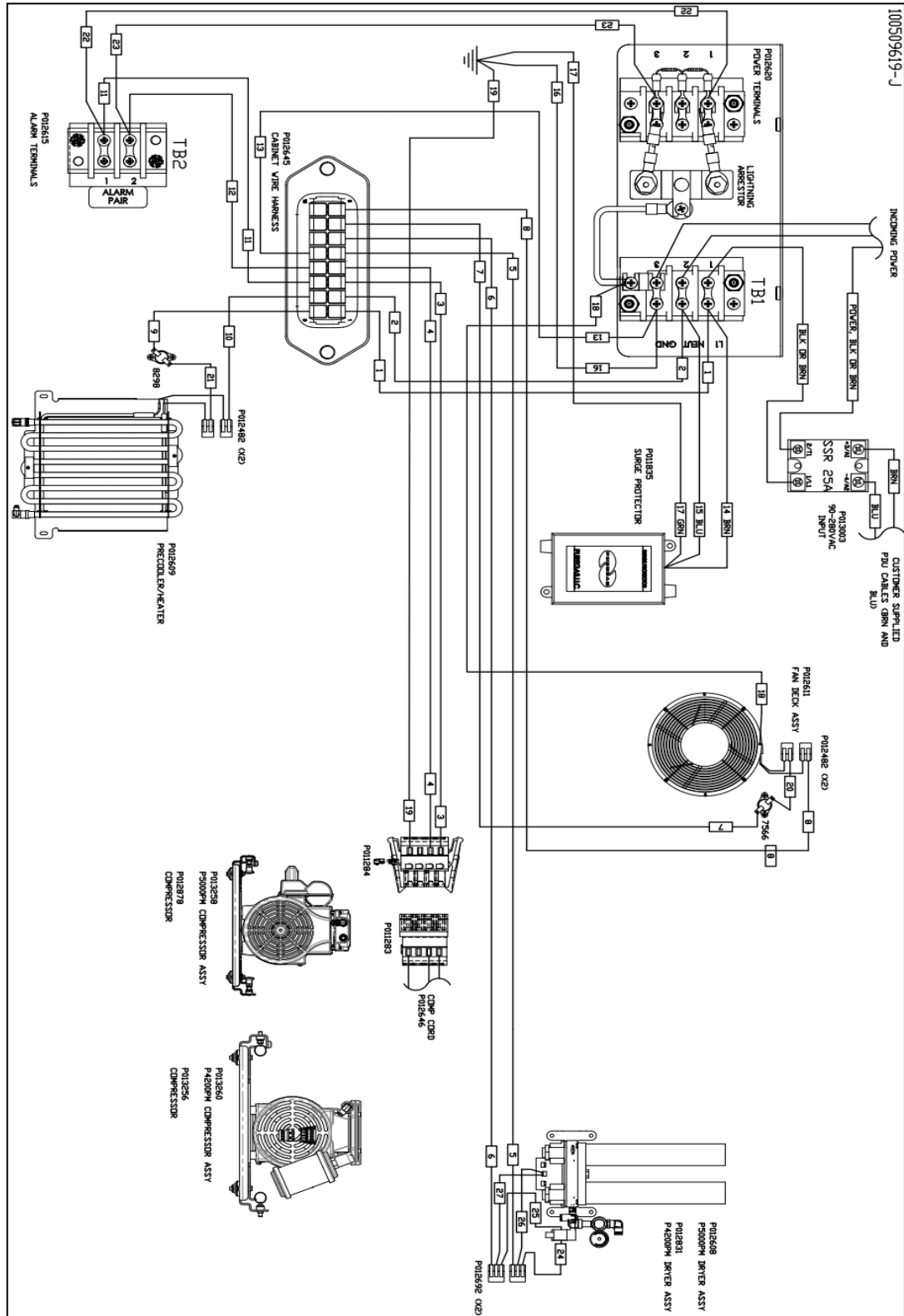

100509619-J

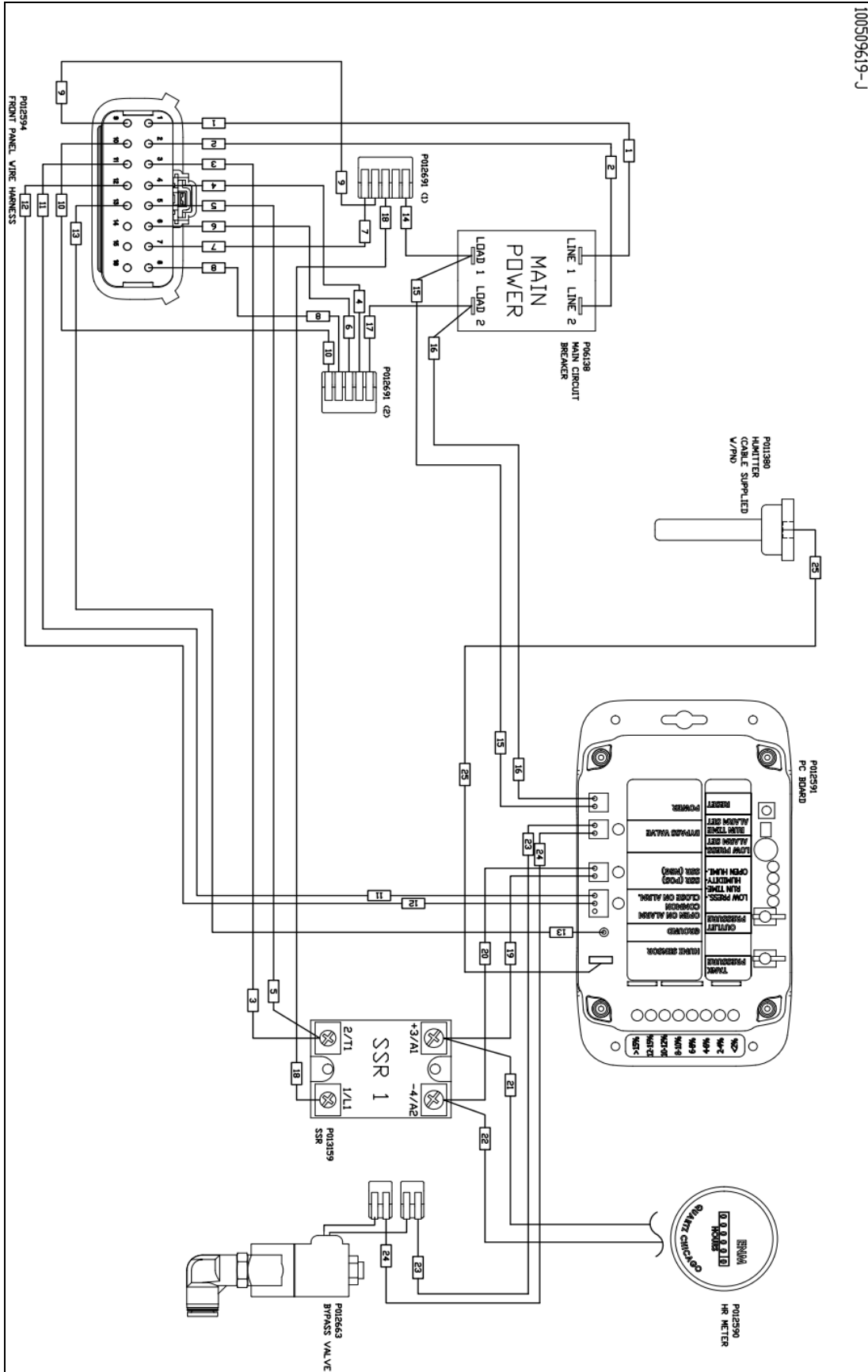

14.2 Set Point Limits and Defaults

14.2.1 System Adjustments

Description	Minimum Value	Maximum Value	Default Value	Unit of Measurement
System Pressure	48.0	52.0	50.0	PSI
Outlet Pressure	1.0	30.0	20.0	PSI

14.2.2 Alarm Set Points

Description	Minimum Value	Maximum Value	Default Value	Unit of Measurement	Shutdown
Low Outlet Pressure Alarm	1.0	9.5	6.5	PSI	
High Humidity Alarm			10.0	%	YES
Excessive Compressor Run Time Alarm	1.0	10.0	3.0	Minutes	

14.2.3 System Operations

Description	ON Value	OFF Value	Default Value	Unit of Measurement
Compressor	*20.0	*50.0		PSI *(+/-3 PSI)
Fan	85.0	67.0		Deg F
Heater	40.0	60.0		Deg F

15. Limited Warranty Agreement

ALTEC AIR products carry a one (1) year warranty against defective workmanship and material. This period starts at date of shipment. Not included are the components subject to normal replacement during a year's operating time.

No claims for labor in replacing defective parts or for consequential damages will be allowed. Replacement parts will be invoiced in the regular way, with invoices subject to adjustment after the parts claimed defective are examined at our factory. In addition, no material or parts will be accepted at our factory for in-warranty repairs or credit without previous authorization from ALTEC AIR.

Responsibility for damages incurred in transit will be borne by the user and the user in turn should file any damage claim against the carrier. All warranty items are F.O.B. Broomfield, Colorado. Freight charges are the responsibility of the user.

This warranty shall not apply to any ALTEC AIR product which shall have been repaired or altered in any way by anyone other than ALTEC AIR or authorized personnel so as to affect, in our judgment, its proper functioning or reliability, neither will it apply to any product which has been subject to misuse, negligence, or accident. The installation of unauthorized non ALTEC AIR parts will void the warranty on those ALTEC AIR products.

Registration Reminder

If you haven't already done so, please take a moment to register your ALTEC AIR P4200PM / P5000PM Air Dryer. **Registering is necessary to activate this Limited Warranty on your product.** Once you register, you are eligible to receive free technical support, as well as updates concerning your ALTEC AIR products.

See Section 7. for details on Registering Your Dryer.

16. Contacting ALTEC AIR

16.1 General

ALTEC AIR, LLC
226A Commerce Street
Broomfield, Colorado 80020

(800) 521-5351

(303) 427-3700

Fax – (303) 657-2233

info@AltecAIR.com

www.AltecAIR.com

16.2 Sales

(800) 521-5351 (**option 2**)

Fax – (303) 657-2205

sales@AltecAIR.com

parts@AltecAIR.com

16.3 Service

(800) 521-5351 (**option 3**)

Fax – (303) 657-2205

16.4 Technical Support

(800) 521-5351 (**option 1**)

DON'T FORGET TO REGISTER YOUR DRYER!

See Section 7. for details on Registering Your Dryer.

