

# P10KW / P15KW Air Dryer



## User's Guide





**WARNING:**

This product can expose you to chemicals including Lead, which is known to the State of California to cause cancer/birth defects or other reproductive harm. For more information go to [www.P65Warnings.ca.gov](http://www.P65Warnings.ca.gov)

## 1. Welcome & Congratulations

Congratulations on your purchase of a new ALTEC AIR P10KW / P15KW Air Dryer! We here at ALTEC AIR are very proud of our products and we are committed to providing you with the best value and service possible.

We are sure that you will be satisfied with your new air dryer and would like to thank you for choosing ALTEC AIR for your air dryer requirements. We also hope that you will continue to choose us for your future air pressure and related product purchases.

For information about this and other ALTEC AIR products, please visit us on the web at:

[www.AltecAIR.com](http://www.AltecAIR.com)

## 2. Introduction

**PLEASE READ THIS USER'S GUIDE THOROUGHLY AND SAVE FOR FUTURE REFERENCE.**

This User's Guide is provided for the benefit of our customers and contains information and direction specific to the ALTEC AIR P10KW / P15KW Air Dryer. It will cover topics including safety, specifications, installation, registration, operation, testing, maintenance, replacement parts, service, and troubleshooting issues. Observation and compliance with this User's Guide will ensure the maximum life and efficiency of your air dryer.

This User's Guide should be read thoroughly prior to installing, operating, or servicing the air dryer in order to become familiar with the recommended procedures. This will minimize the possibility of personal injury or damage to the unit due to improper operation or handling.

### 3. Table of Contents

<b>1. Welcome &amp; Congratulations .....</b>	<b>3</b>	8.11 Setting the System Pressure .....	45
<b>2. Introduction .....</b>	<b>3</b>	8.12 Setting the Static Pressure .....	47
<b>3. Table of Contents.....</b>	<b>4</b>	8.13 Setting the Outlet Pressure .....	48
<b>4. Safety &amp; Warning Information .....</b>	<b>6</b>	<b>9. Testing Your Dryer .....</b>	<b>49</b>
<b>5. Overview &amp; Specifications.....</b>	<b>9</b>	9.1 Safety & Warning Information .....	49
5.1 Product Description .....	9	9.2 Measuring Compressor Amp Draw .....	51
5.2 Key Features .....	9	9.3 Measuring Voltage to Compressor .....	52
5.3 Dryer Function Overview .....	10	9.4 Measuring Incoming Voltage .....	53
5.4 Technical Specifications .....	12	9.5 Testing High Outlet Pressure Alarm.....	54
<b>6. Installing Your Dryer .....</b>	<b>13</b>	9.6 Testing Low Outlet Pressure Alarm.....	55
6.1 Safety & Warning Information .....	13	9.7 Testing Low System Pressure Alarm.....	56
6.2 Before You Begin .....	15	9.8 Testing Consistent Heatless Dryer Cycling.....	58
6.3 Included Contents .....	16	9.9 Measuring Heatless Dryer Solenoid Voltage.....	59
6.4 Required Tools and Materials.....	16	9.10 Testing Precooler Fan .....	60
6.5 Installation Steps.....	17	9.11 Testing Low Water Sensor Function & System Shutdown .....	60
6.6 Installation Checklist .....	29	9.12 Testing Dump Water Sensor Function.	61
<b>7. Registering Your Dryer.....</b>	<b>30</b>	9.13 Testing High Water Sensor Function...	63
<b>8. Operating Your Dryer .....</b>	<b>31</b>	9.14 Testing Water Dump Solenoid Valve ..	65
8.1 Safety & Warning Information .....	31	9.15 Testing Humidity Alarm and System Shutdown .....	66
8.2 Connecting Air Lines to the Dryer .....	32	9.16 Testing Fittings & Hoses for Leaks .....	69
8.3 Powering the Dryer ON & OFF.....	32	<b>10. Maintaining Your Dryer .....</b>	<b>70</b>
8.4 Using the Front Panel Display .....	33	10.1 Safety & Warning Information .....	70
8.5 Identifying Dryer Alarms .....	35	10.2 Six Month Maintenance .....	72
8.6 Adjusting & Resetting Dryer Set Points	38	<b>11. Replacement Parts &amp; Accessories .....</b>	<b>73</b>
8.7 Opening Panels .....	43	11.1 Top Section Parts .....	73
8.8 Connecting to Common Alarm Terminals .....	43	11.2 Middle Section Parts .....	74
8.9 Connecting to Discrete Alarm Terminals .....	44	11.3 Heatless Dryer Assembly Parts.....	75
8.10 Depressurizing the Dryer .....	44	11.4 Lower Section Parts .....	76
		11.5 Frame Section Parts .....	77
		11.6 Accessories for Your Dryer .....	78

11.7 Ordering Parts from ALTEC AIR .....	78	13.16 Can't Create a Low Water Alarm .....	87
<b>12. Service &amp; Repair.....</b>	<b>79</b>	13.17 High Water Alarm .....	88
12.1 Services Offered .....	79	13.18 Can't Create a High-Water Alarm .....	88
12.2 Initiating a Service Transaction .....	79	13.19 High Water Temperature Alarm .....	88
<b>13. Troubleshooting Your Dryer .....</b>	<b>80</b>	13.20 Compressor Doesn't Operate .....	89
13.1 Before You Call ALTEC AIR .....	80	13.21 Unit Trips Breaker .....	89
13.2 Safety & Warning Information .....	80	13.22 Inconsistent Heatless Dryer Cycling ..	90
13.3 Air Dryer Won't Power ON.....	82	13.23 Contacting ALTEC AIR Technical Support.....	90
13.4 Display Screen Not Functioning.....	82	<b>14. Appendix .....</b>	<b>91</b>
13.5 Low System Pressure Alarm .....	83	14.1 Wiring Diagram .....	91
13.6 Can't Create a Low System Pressure Alarm.....	83	14.2 Set Point Limits and Defaults .....	92
13.7 High Outlet Pressure Alarm.....	83	<b>15. Limited Warranty Agreement.....</b>	<b>93</b>
13.8 Can't Create a High-Pressure Alarm ...	84	Registration Reminder .....	93
13.9 Low Outlet Pressure Alarm .....	84	<b>16. Contacting ALTEC AIR .....</b>	<b>94</b>
13.10 Can't Create a Low-Pressure Alarm ..	84	16.1 General.....	94
13.11 High Flow Rate Alarm.....	85	16.2 Sales.....	94
13.12 High Humidity .....	85	16.3 Service .....	94
13.13 Can't Create a High Humidity Alarm / Shutdown.....	86	16.4 Technical Support.....	94
13.14 High Outlet Temperature Alarm.....	87	<b>17. Notes.....</b>	<b>95</b>
13.15 Low Water Alarm .....	87		

## 4. Safety & Warning Information

This section contains general information about safety and warning points to consider and adhere to during installation, operation, and maintenance of your air dryer. PLEASE READ THIS SECTION BEFORE PERFORMING ANY OPERATION OR PROCEDURE ON YOUR AIR DRYER.

Additional warnings specific to an operation or procedure will also be presented throughout the following sections. These will include the  symbol as well as a label of “**WARNING!**”, “**CAUTION!**”, or “**IMPORTANT!**”. Please be sure to pay close attention for these warnings and read them as you encounter them.



### **WARNING!**

For your safety, all the information in this User's Guide must be followed to minimize the risk of electrical shock and prevent property damage or personal injury.



### **WARNING!**

Extreme care should be exercised to avoid contact with live electrical circuits. Many procedures performed during installation, operation, testing, and maintenance of this air dryer require the equipment to be running, creating a situation for potential electrical shock. It is highly recommended that you remove all jewelry before performing any procedures.



### **WARNING!**

Internal surfaces may be hot. Use care when coming into contact with internal components as there is a potential for some of these components to become hot when in operation or standby.

**WARNING!**

**High Noise.** ALTECAIR air dryers are meant to be installed in an unattended area.

**CAUTION!**

Proper Installation & Maintenance as outlined in this User's Guide is extremely important to ensure the reliability and longevity of the equipment as well as prevent damage or personal injury.

**CAUTION!**

Depressurizing the air dryer may be necessary before performing certain procedures. **NEVER** remove pressure sensing tubes from the Control Board without depressurizing the air dryer first, or **damage to the Control Board will occur.**

**CAUTION!**

Incoming power to Air Dryer must be:

- 30-amp service recommended
- 230 VAC +/- 10%, 1 Phase for P10KW model
- 208 VAC +/- 10%, 3 Phase for P15KW model
- If hard wiring directly, reference local NEC guidelines

**CAUTION!**

This Air Dryer does not contain an internal Surge Protection Device (SPD). If an SPD is required, it must be supplied by the user.

**CAUTION!**

**DO NOT USE DISTILLED OR DE-IONIZED WATER IN THIS UNIT.** It will cause damage to the compressor and other major components over time. This unit is designed for **clean tap water only.**

**CAUTION!**

Observe precautions for handling **Electrostatic Sensitive Devices.**

**IMPORTANT!**

Performing routine maintenance as outlined in the *Maintaining Your Dryer* section will ensure optimal performance over the lifecycle of your air dryer.

**IMPORTANT!**

Performing procedures not described in this User's Guide or installing components not supplied by ALTECAIR is **NOT RECOMMENDED AND MAY VOID THE WARRANTY.**

**IMPORTANT!**

If installing more than one air dryer in the same location, use individual drain tubing. If plumbed together, damage to the air dryers may occur.

**IMPORTANT!**

Installation of ALTECAIR air dryers are intended for network telecommunication facilities (non-customer premises) only.



## 5. Overview & Specifications

### 5.1 Product Description

The P10KW / P15KW Air Dryer from ALTEC AIR is designed to intake wet ambient air and remove the moisture for delivery to applications requiring a constant, on-demand source of dry, pressurized air. This process is fully automatic and will remain consistent with minimal required periodic maintenance. This dryer is designed specifically for indoor use.

The P10KW / P15KW Air Dryer employs a fully digital operating platform offering the most accurate readings of dryer variables, removable access panels allowing easier access for adjustment and maintenance, heatless desiccant air-drying process, and a single water sealed air compressor.

### 5.2 Key Features

- Real-time monitoring of over 15 points
- Open design for easy maintenance
- Remote alarm reset capabilities
- LCD display of operating parameters
- Solid state microprocessor-based circuitry
- Accurate humidity sensing within  $\pm 0.1\%$  RH
- Single water sealed compressor
- Dual pressure outlets

### 5.3 Dryer Function Overview

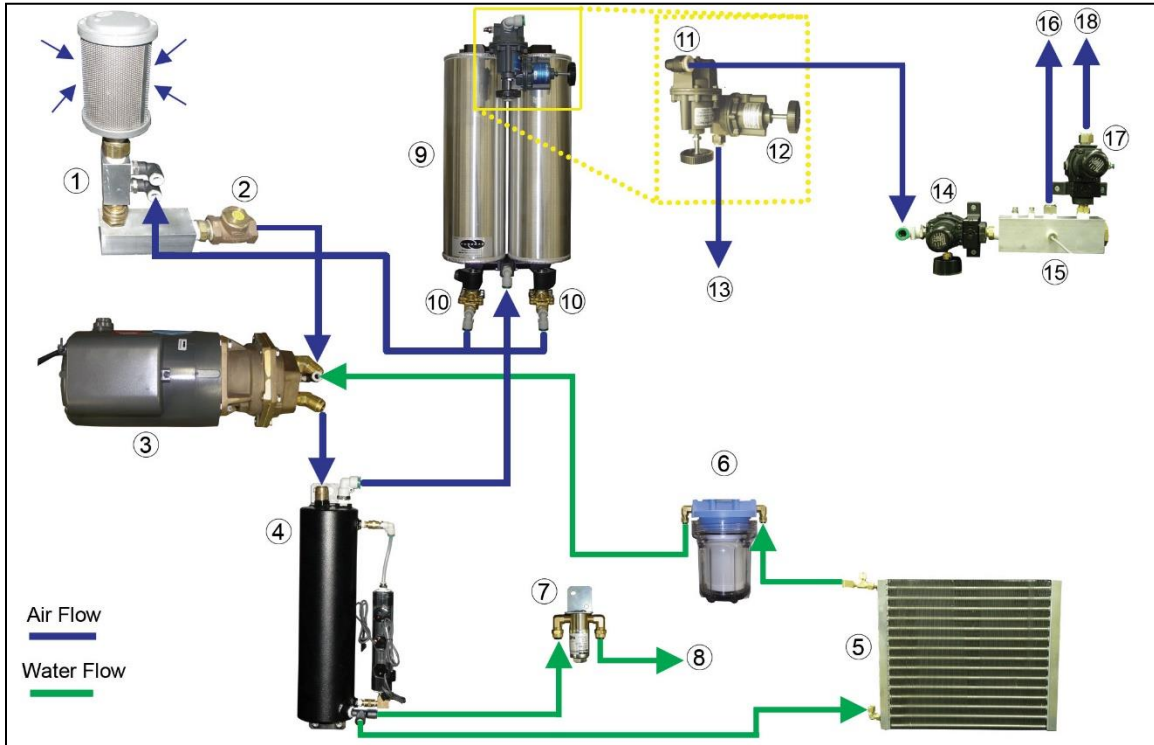

#	Component	Description
1	Inlet Manifold	Draws in ambient and purged air.
2	Check Valve	Prevents the return of air or water from the compressor.
3	Compressor	Creates compressed air.
4	Water Separator	Separates water from compressed air.
5	Precooler	Cools water from the compressor.
6	Water Filter	Filters water.
7	Dump Valve	Dumps excessive water from the water separator.
8	Drain Outlet	Outputs the water released by the dump valve.
9	Heatless Dryer	Removes moisture from compressed air.
10	Purge Valves	Returns moisture from the towers to the inlet manifold.
11	Back Pressure Valve	Maintains operating pressure and prevents overflowing of the air dryer.
12	Bypass Valve	Relieves system pressure to prevent over-pressurizing the system.
13	Bypass Outlet	Outputs the excess air regulated by the Bypass Valve
14	Static Pressure Regulator	Regulates the static pressure (17 PSI). Maintains constant pressure on the combo block for accurate flow measuring.
15	Combo Block	Measures the flow of compressed air, houses the humitter and outlet temperature probe.
16	Static Pressure Outlet	Outputs the air at the pressure set by the Static Pressure Regulator (17 PSI).
17	Adjustable Pressure Regulator	Regulates the outlet pressure.
18	Pressure Outlet	Outputs the air at the pressure set by the Adjustable Pressure Regulator.

## 5.4 Technical Specifications

	<b>P10KW</b>	<b>P15KW</b>
<b>Output Capacity</b>	10,000 SCFD	15,000 SCFD
<b>Power Requirements</b>	230 VAC +/- 10%, 1 Phase, 60 Hz	208 VAC +/- 10%, 3 Phase, 60 Hz
<b>Electrical Characteristics</b> (20 Amp service recommended)	Running Amps: 11.5	Running Amps: 10.5
<b>Outlet Pressure Range</b>	Variable Pressure Outlet: 0 – 15 PSI (adjustable) Static Pressure Outlet: 17 PSI	
<b>Outlet Air Humidity</b>	Less than 2% RH	
<b>Compressor Type</b>	Water sealed, 2 HP, 1 Phase	Water sealed, 3 HP, 3 Phase
<b>Drying Method</b>	Heat-less Desiccant	
<b>Operating Temperature Range</b>	40° to 85°F (5° to 30°C) optimal	
<b>Noise Level</b>	86.6 dBA	
<b>Heat Dissipation</b>	7,500 BTU/hr.	11,900 BTU/hr.
<b>Alarms</b>	Standard alarms – complete readings of all critical measurement points, individual alarm indication display	
<b>Outlet Connections</b>	Variable Pressure Outlet: 3/4" NPT Female Static Pressure Outlet: 3/4" NPT Female	
<b>Dimensions</b>	24" D x 28" W x 51.25" H (61 cm x 71.1 cm x 130 cm)	
<b>Net / Shipping Weight</b>	355 lbs. (161 kgs) / 409 lbs. (185.5 kgs)	

## 6. Installing Your Dryer

### 6.1 Safety & Warning Information



#### **WARNING!**

**Internal surfaces may be hot.** Use care when coming into contact with internal components as there is a potential for some of these components to become hot when in operation or standby.



#### **WARNING!**

**Extreme care should be exercised to avoid contact with live electrical circuits.** Many procedures performed during installation, operation, testing, and maintenance of this air dryer require the equipment to be running, creating a situation for potential electrical shock. It is highly recommended that you remove all jewelry before performing any procedures.



#### **WARNING!**

**High Noise.** Altec AIR air dryers are meant to be installed in an unattended area.



#### **CAUTION!**

Proper Installation & Maintenance as outlined in this User's Guide is extremely important to ensure the reliability and longevity of the equipment as well as prevent damage or personal injury.

**CAUTION!**

Incoming power to Air Dryer must be:

- 30-amp service recommended
- 230 VAC +/- 10%, 1 Phase for P10KW model
- 208 VAC +/- 10%, 3 Phase for P15KW model
- If hard wiring directly, reference local NEC guidelines

**CAUTION!**

This Air Dryer does not contain an internal Surge Protection Device (SPD). If an SPD is required, it must be supplied by the user.

**IMPORTANT!**

Installation of ALTECAIR air dryers are intended for network telecommunication facilities (non-customer premises) only.

**IMPORTANT!**

If installing more than one air dryer in the same location, use individual drain tubing. If plumbed together, damage to the air dryers may occur.

**IMPORTANT!**

Performing procedures not described in this User's Guide or installing components not supplied by ALTECAIR is NOT RECOMMENDED AND MAY VOID THE WARRANTY.

## 6.2 Before You Begin

**6.2.1** Carefully inspect the unit, including the shipping box as well as the air dryer, for **ANY DAMAGE CAUSED BY SHIPPING**. If any shipping damage is detected, it is important to file a claim with the shipping company prior to continuing the installation procedures.

**6.2.2** Read the entire *Installing Your Dryer* section to familiarize yourself with the components and procedures before performing the air dryer installation.

**6.2.3** Verify the installation location of the air dryer:

**6.2.3.1** Well ventilated and free from abrasive dust or chemicals.

**6.2.3.2** Unobstructed drain or bucket for water dump.

**6.2.3.3** Ambient temperature is between 40° and 85° F (optimum).

**NOTE:** Higher temperatures will decrease component lifespan.

**6.2.3.4** Meets the following power requirements:

- 230 VAC +/- 10%, 1 Phase for P10KW
- 208 VAC +/- 10%, 3 Phase for P15KW
- Minimum 30-amp service
- If hard wiring directly, reference local NEC guidelines

**6.2.4** Notify the alarm center of the installation and potential for alarms during the process (as necessary).

### 6.3 Included Contents

(1) P10KW / P15KW Air  
Dryer

(1) Installation Guide (not  
shown)

Package located inside the  
dryer:

(1) User's Guide -

*Paper copy or digital file on CD (not shown)*

(1) 10' – 3/8" Tubing

(1) Purge Muffler

(1) Compressor Connector Tool

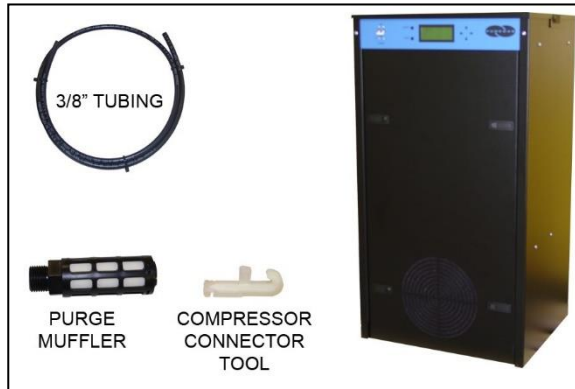

### 6.4 Required Tools and Materials

- Large adjustable wrench
- Medium adjustable wrench
- 7/16" wrench
- Band cutters or snips
- 1+ gallon of clean tap water  
**(DO NOT USE  
DISTILLED WATER)**
- Small funnel
- 20-amp 250 VAC plug  
(recommended)
- Pipe dope or pipe thread tape
- Cup of soapy water
- 1-inch paint brush  
(recommended)



## 6.5 Installation Steps

### 6.5.1 Remove all shipping materials.

**NOTE:** If ANY SHIPPING DAMAGE is detected, file a claim with the shipping company prior to continuing the installation procedures.



### 6.5.2 Place the dryer at the operating location.

### 6.5.3 Remove the front panel.



### 6.5.4 Check for loose parts, hoses, or wiring.

**NOTE:** If ANY SHIPPING DAMAGE is detected, file a claim with the shipping company prior to continuing the installation procedures.



- 6.5.5** Using a 7/16" wrench remove the shipping block from under the compressor plate.

Discard block and bolt.



- 6.5.6** Remove the ship-loose contents package.



**On BACK of dryer:**

- 6.5.7** Verify that the black orifice plug is still installed where shown.

- 6.5.8** Install the purge muffler (optional).

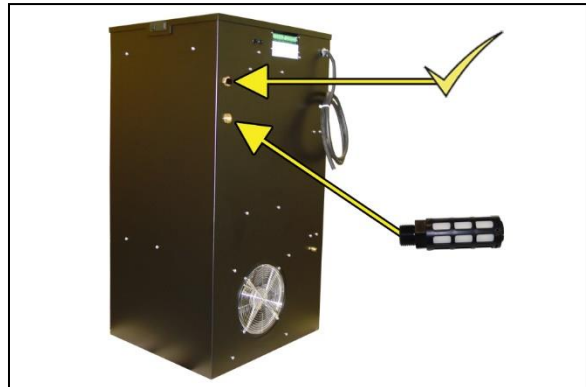

**6.5.9** Install 3/8" drain tubing and route to an unobstructed drain or bucket.



**6.5.10** Verify that the dryer is powered **OFF**.

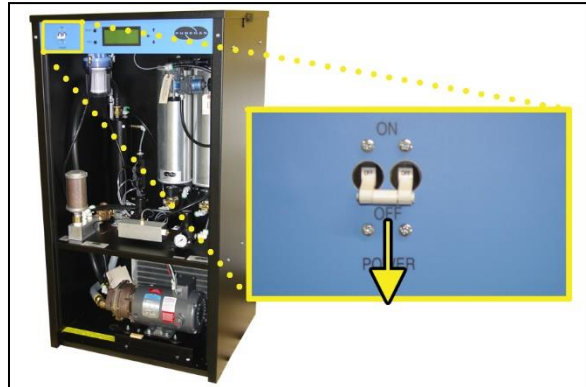

**6.5.11** Wire directly or plug the power cord into a power outlet:

- 230 VAC +/- 10%,  
1 phase for the **P10KW**
- 208 VAC +/- 10%,  
3 phase for the **P15KW**

**NOTE:** ALTEC AIR recommends using a 20-amp 250 VAC plug. (not provided)

**6.5.12** Prime the compressor:

**⚠ CAUTION:** The following steps must be performed to avoid **damage to the compressor**.

**6.5.12.1** Using a 9/16" wrench disconnect tube from water filter.

**6.5.12.2** Using a funnel (not provided), slowly pour water into the tube.

**6.5.12.3** Add water until tube is full.

**6.5.12.4** Reinstall the tubing to the water filter.

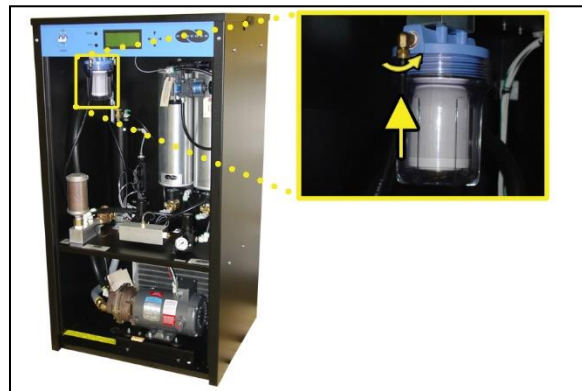
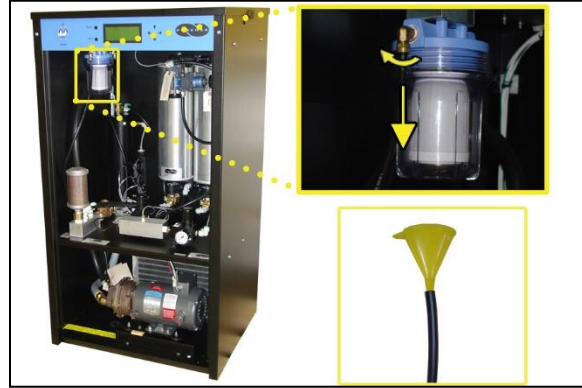

**6.5.13** Press down on the quick disconnect fitting collar to remove the inlet manifold assembly. Set the inlet manifold assembly to the side.

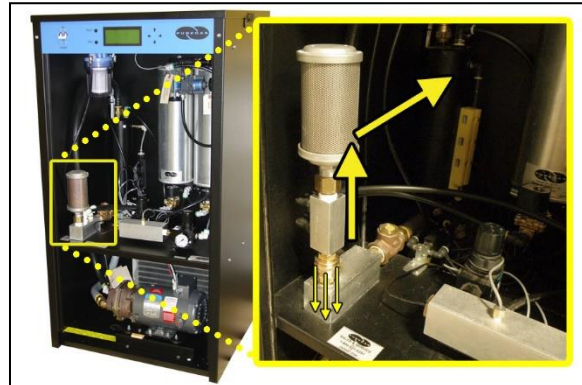

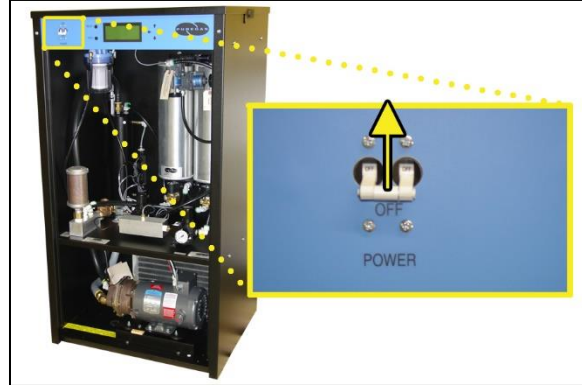
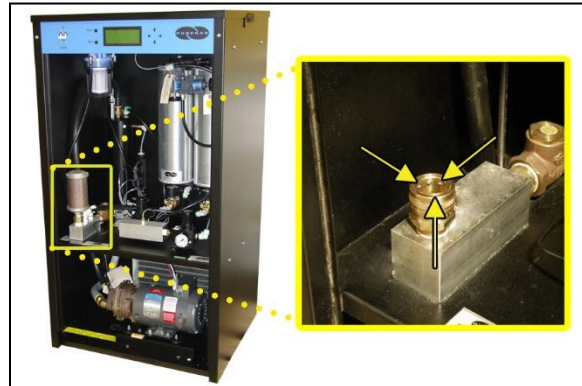
**6.5.14** Power the dryer **ON**.**6.5.15** Slowly add approximately half a gallon of water.

**NOTE:** If water is **NOT** being drawn into the compressor move to the next step.  
If the water **IS** being drawn into the compressor move to step 6.5.17

**6.5.16** Interchange the compressor wires. (Skip these steps if water is being drawn into the compressor)**6.5.16.1** Power the dryer **OFF**. (section 6.5.10 )

**6.5.16.2** Use the Compressor Connector Tool to remove the Red & Black wires from the dryer side connector.

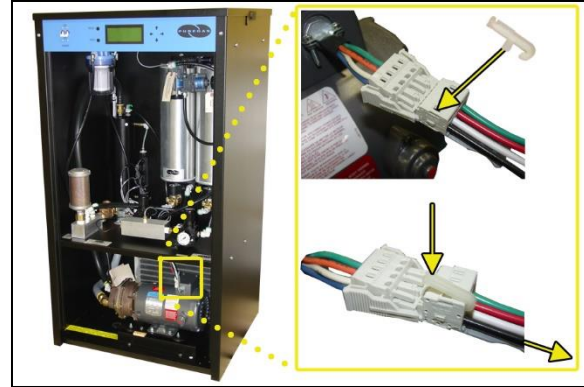

**6.5.16.3** Switch the Red & Black wires and re-insert.

**6.5.16.4** Power the dryer **ON**. (section 6.5.14 )

**6.5.17** Continue adding water until the water level stabilizes below the middle water sensor.

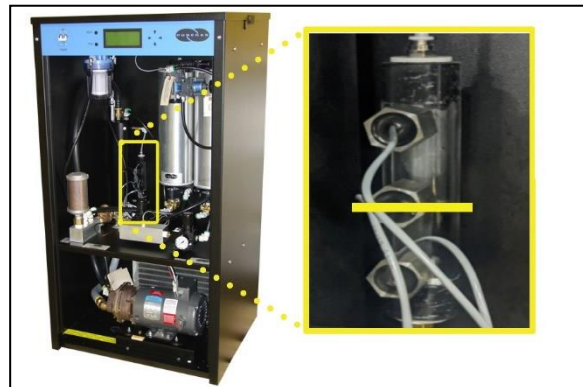

**6.5.18** Reinstall the inlet manifold assembly by pressing down on the quick disconnect fitting collar and inserting male coupling fitting.

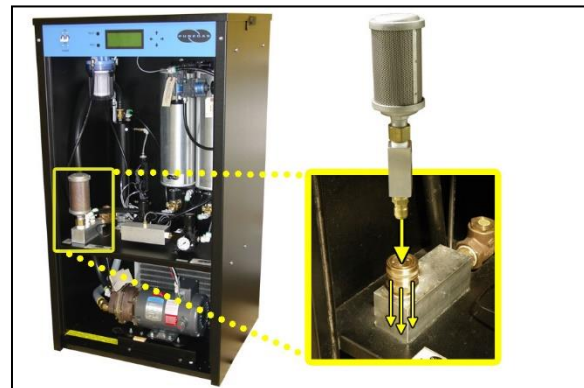



**6.5.19** Let the dryer run until the Humidity drops under 2% (may take up to 15 minutes).

**NOTE:** Press **RESET** if the System goes into **SHUTDOWN**.

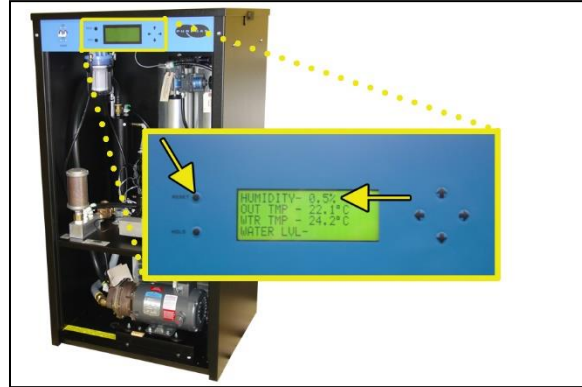

**6.5.20** Power the dryer **OFF**.

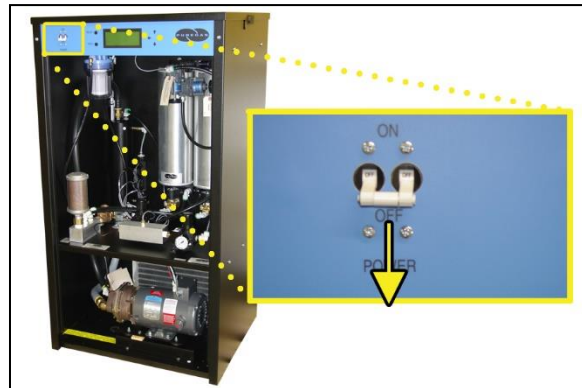

**6.5.21** Connect the air supply line(s) to the dryer Outlet Pressure and/or Static Pressure port(s).

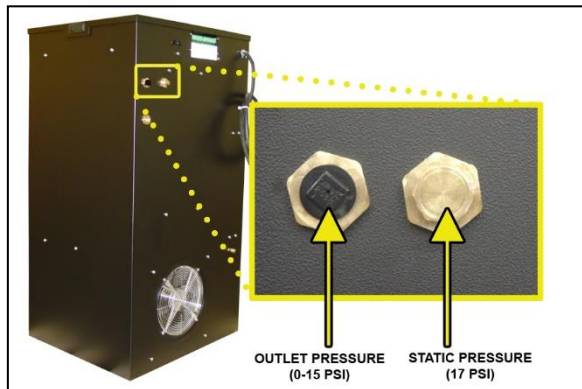

**⚠ CAUTION:** Be careful when removing outlet plug(s). System may be pressurized.

*ALTEC AIR recommends using Installation Kit **P011890** to connect your air dryer to the air supply line (See section 11.6 for detail).*

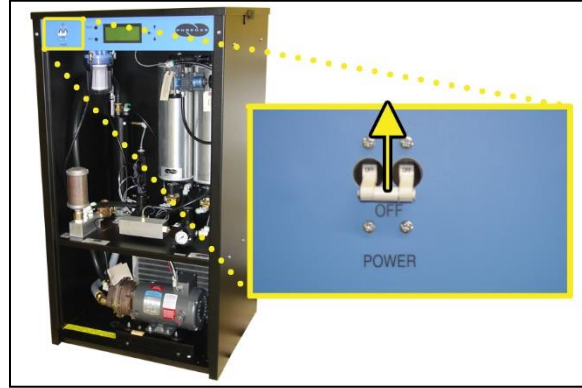
**6.5.22** Power the dryer **ON**.**6.5.23** Set the System Pressure According to Elevation Chart Below:

**6.5.23.1** Set system pressure to within (+/- 0.5 PSI) per the elevation chart below. Setting above tolerance **WILL** lead to increased motor load which may lead to a tripped circuit breaker. Setting below tolerance may lead to higher humidity within the system.

SYSTEM PRESSURE AT VARIOUS ALTITUDES							
ELEVATION ABOVE SEA LEVEL(ft.)	0	2000	4000	6000	8000	10000	12000
BACK PRESSURE REGULATOR SETTING	25	24	23	22	21	20	19
BYPASS RELIEF VALVE SETTING	26	25	24	23	22	21	20

**6.5.23.2** When the Unit Screen (8.4.4.1 ) appears on the display, press the **HOLD Button** on the Front Panel to freeze that screen.

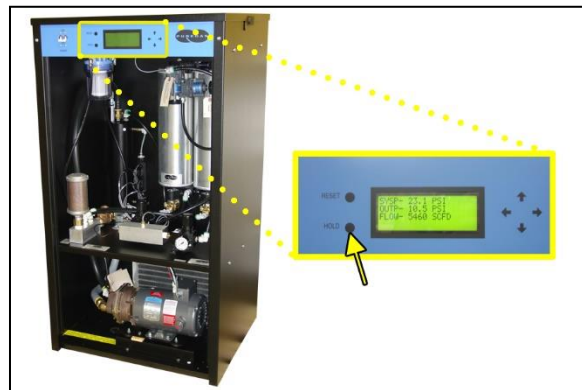



**6.5.23.3** Unlock the knob on the Bypass and Back Pressure Valves by loosening the retaining nuts.



**6.5.23.4** Turn the Bypass Valve Clockwise until it is completely closed.

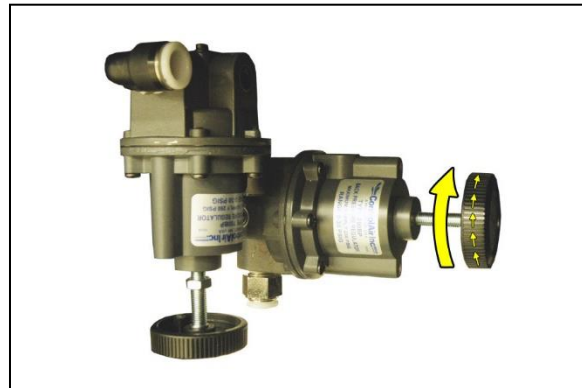

**6.5.23.5** Push the Back Pressure Tube in and hold the green ferrule. While holding the ferrule pull the tube out.

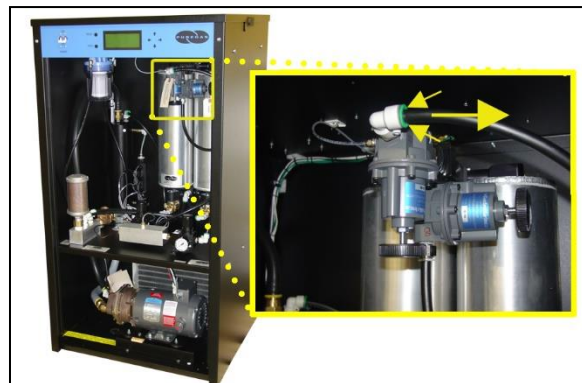

**6.5.23.6** Adjust Back Pressure Valve until the **SYSP** reading on the Front Panel Display is correct according to your elevation. (see chart 6.5.23 )

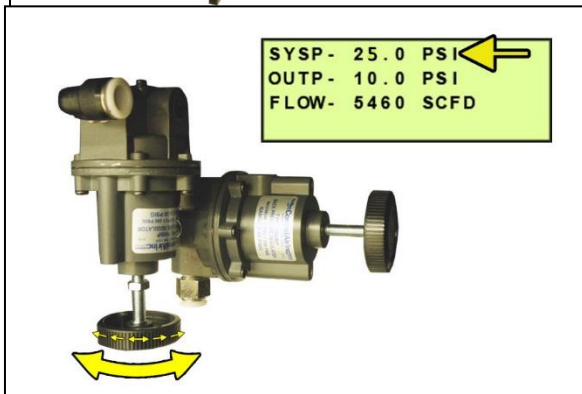

**6.5.23.7** Reinstall Back Pressure Tube.

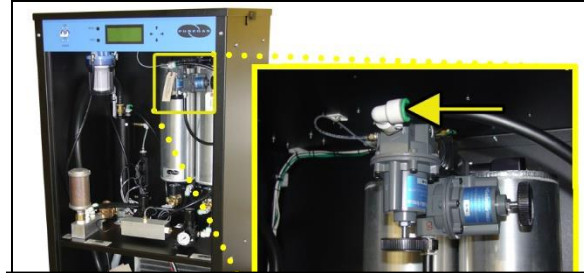

**6.5.23.8** Open the Bypass Valve until the **SYSP** reading on the Front Panel Display is correct according to your elevation. (see chart 6.5.23 )

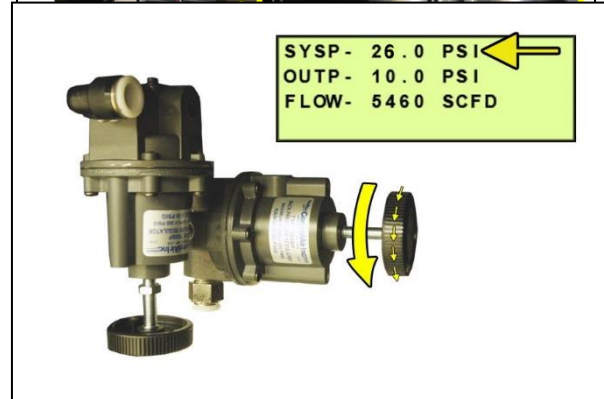

**6.5.23.9** Lock retaining nuts on the Bypass and Back Pressure Valves.

**6.5.24** Set the Static Pressure:

**6.5.24.1** Pull the Static Pressure Regulator knob out.

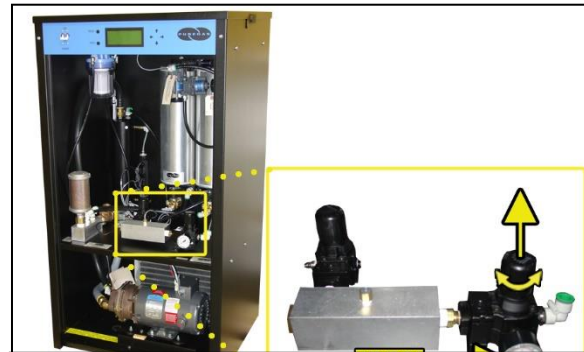

**6.5.24.2** Turn the knob until the reading on the pressure gauge is **17 PSI**.

**6.5.24.3** Push knob in to lock.

**6.5.25** Set the Outlet Pressure:

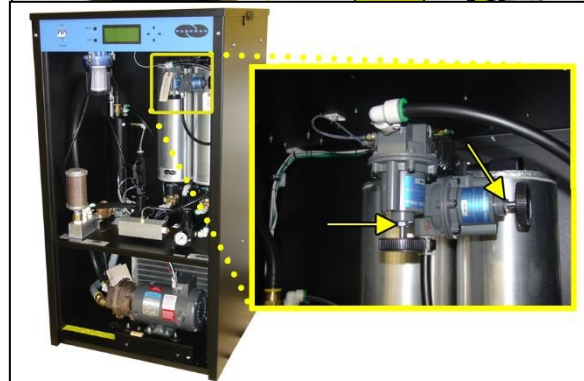

**6.5.25.1** When the Unit Screen (8.4.4.1 ) appears on the display, press the **HOLD Button** on the Front Panel to freeze that screen.



**6.5.25.2** Pull the Outlet Pressure Regulator knob out.

**6.5.25.3** Turn knob until Outlet Pressure (**OUTP**) reading is at the desired setting.

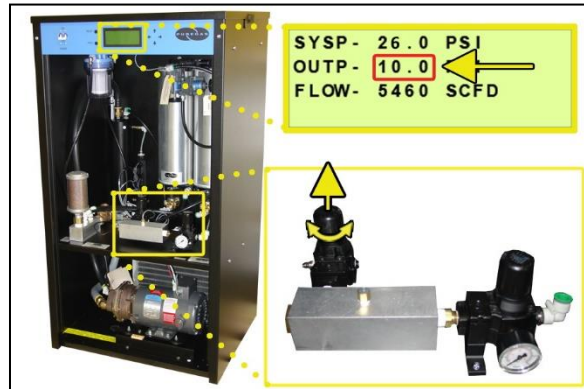

**6.5.25.4** Push knob in to lock.

**6.5.26** Check for leaks:

**NOTE:** This is a general procedure that can be applied to any fitting or hose that has air pressure in it. **DO NOT SOAP TEST THE HUMITTER FITTING. DAMAGE TO THE HUMITTER MAY OCCUR.**

**6.5.26.1** Visually inspect for water leaks.

**6.5.26.2** Listen for any 'hissing' sounds which may indicate a fitting or hose air leak.

**6.5.26.3** Use a 1-inch paint brush to dab soapy water on the air fitting or hose connection to be tested.

If air bubbles appear at the connection, this indicates that air is leaking from the connection.



*If any leaks are detected, take steps to seal them off (as necessary):*

- *Tighten the fitting*
- *Re-connect the hose end*
- *Replace the fitting / hose / component*

**6.5.27** Re-install the front panel.

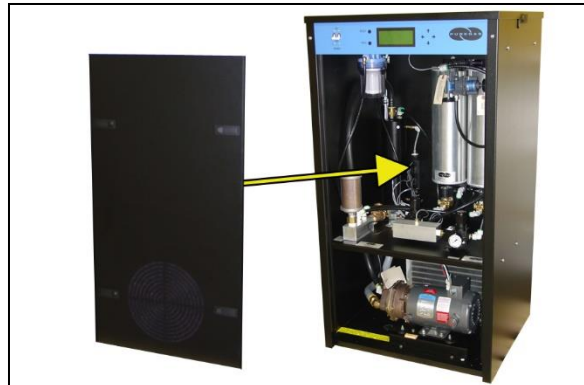

**6.5.28 REGISTER YOUR DRYER.** *See section 7. for details.*

## 6.6 Installation Checklist

- No shipping damage was detected.
- Dryer location meets the following requirements:
  - Well ventilated
  - Free from abrasive dust or chemicals
  - Unobstructed drain for water dump
  - Ambient temperature is between 40° and 85° F (optimum)
- Shipping block removed from compressor trays.
- System Pressures are set to according to your elevation.
- Static Pressure is set to 17 PSI.
- No leaks are present in the system.
- No alarms are present on the Display Panel.

## 7. Registering Your Dryer

Please take a moment to register your ALTEC AIR P10KW / P15KW Air Dryer. Registering is necessary to activate the Limited Warranty on your product. Once you register, you are eligible to receive free technical support, as well as updates concerning your ALTEC AIR products.

Register Online at [www.AltecAIR.com/registration](http://www.AltecAIR.com/registration)

Or by Phone 1-800-521-5351 (option 2)

Have the following information available:

Model #: **P10KW / P15KW** Serial #: \_\_\_\_\_

Company Name: \_\_\_\_\_ Location Name: \_\_\_\_\_

Shipping Address: \_\_\_\_\_

City: \_\_\_\_\_ State: \_\_\_\_\_ Zip Code: \_\_\_\_\_

Contact Name: \_\_\_\_\_ Phone #: ( ) - ext. \_\_\_\_\_

Email: \_\_\_\_\_

## 8. Operating Your Dryer

### 8.1 Safety & Warning Information



#### **WARNING!**

**Extreme care should be exercised to avoid contact with live electrical circuits.** Many procedures performed during installation, operation, testing, and maintenance of this air dryer require the equipment to be running, creating a situation for potential electrical shock. It is highly recommended that you remove all jewelry before performing any procedures.



#### **WARNING!**

**Internal surfaces may be hot.** Use care when coming into contact with internal components as there is a potential for some of these components to become hot when in operation or standby.



#### **WARNING!**

**High Noise.** Altec AIR air dryers are meant to be installed in an unattended area.



#### **CAUTION!**

Observe precautions for handling **Electrostatic Sensitive Devices.**



### **IMPORTANT!**

Performing procedures not described in this User's Guide or installing components not supplied by ALTEC AIR is NOT RECOMMENDED AND MAY VOID THE WARRANTY.

## 8.2 Connecting Air Lines to the Dryer

**8.2.1** Connect the air supply line(s) to the dryer Outlet Pressure port (adjustable between 0-15 PSI) and/or the Static Pressure port (non-adjustable at 17 PSI)

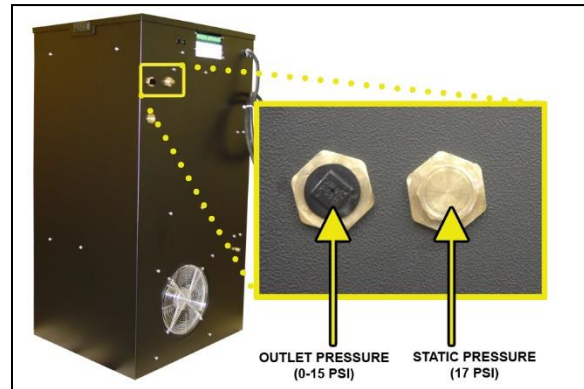

**⚠ CAUTION:** Be careful when removing outlet plugs. System may be pressurized.

*ALTEC AIR recommends using Installation Kit P011890 to connect your air dryer to the air supply line(s) (See section 11.6 for detail).*

## 8.3 Powering the Dryer ON & OFF



### **CAUTION!**

Incoming power to Air Dryer must be:

- 30-amp service recommended
- 230 VAC +/- 10%, 1 Phase for P10KW model
- 208 VAC +/- 10%, 3 Phase for P15KW model
- If hard wiring directly, reference local NEC guidelines



- 8.3.1 POWER Circuit Breaker -**  
Controls the main power to the dryer.



## 8.4 Using the Front Panel Display



### **CAUTION!**

The Display Screen is covered by a clear protective layer that guards against Electrostatic Discharge (ESD). **DO NOT REMOVE THIS LAYER.**



- 8.4.1 RESET Button** – Clears an alarm and allows the system to continue operating.
- 8.4.2 HOLD Button** – Freezes the current information screen on the display. When pressed again, it will allow the information screens to begin cycling again.
- 8.4.3 Arrow Buttons** – Used to access, navigate, and change values in the Set Point Adjust screens.

**8.4.4 Display Screen** - Shows the current dryer readings. Will cycle between the following information screens (unless the **HOLD** button has been pressed):

**8.4.4.1 SYSP Screen**

<b>SYSP -</b>	<b>26 . 0</b>	<b>PS I</b>
<b>OUTP -</b>	<b>10 . 1</b>	<b>PS I</b>
<b>FLOW -</b>	<b>54 61</b>	<b>SCFD</b>

**SYSP** – System Pressure – system operating pressure.

**OUTP** –Outlet Pressure regulated by the Outlet Pressure Regulator

**FLOW** – Air Flow Rate

**8.4.4.2 Humidity Screen**

<b>HUMIDITY -</b>	<b>0 . 0%</b>
<b>OUT TMP -</b>	<b>71 . 3 ° F</b>
<b>WTR TMP -</b>	<b>72 . 5 ° F</b>
<b>WATER LVL -</b>	

**HUMIDITY** – Humidity level of System.

**OUT TMP** – Temperature of the outlet pressure.

**WTR TMP** – Temperature of the water.

**WATER LVL** – Current status of the water level.

- **<Blank>** – Indicates a normal water state.
- **Low** – Indicates a low water state.
- **Dump** – Indicates the dryer is ejecting excess water.
- **High** - Indicates a high-water state.

### 8.4.4.3 System Stat Screen

```

SYSTEM STAT - ON
COMP RUN - 19HRS
TOWER - TWR 1

```

**SYSTEM** - Running Status of System:

- **ON** – System is Online.
- **SHUTDOWN** – System has been shut down as a result of either a Humidity, High Outlet Temperature, or High-Water Temperature alarm.

**COMP RUN** – How many hours the compressor has run since the last Total Hour Reset.

**TOWER** – Status of the Tower Purge:

- **TWR1** – Tower 1 is purging.
- **TWR2** – Tower 2 is purging.

## 8.5 Identifying Dryer Alarms

### 8.5.1 System Pressure Alarm –

Occurs when the System Pressure (**SYSP**) drops below the alarm set point for more than one (1) minute. (Default setting is 18.0 PSI)

```

SYSP - 17.0 PSI ALR
OUTP - 10.1 PSI
FLOW - 5461 SCFD

```

*See section 13.5 for troubleshooting information*

### 8.5.2 High Outlet Pressure Alarm -

Occurs when the Outlet Pressure (**OUTP**) rises above the alarm set point for more than one (1) minute. (Default setting is 12.0 PSI)

```

SYSP - 26.0 PSI
OUTP - 13.0 PSI HALR
FLOW - 5461 SCFD

```

*See section 13.7 for troubleshooting information.*

**8.5.3 Low Outlet Pressure Alarm –**

Occurs when the Outlet Pressure (**OUTP**) drops below the alarm set point for more than one (1) minute.  
(Default setting is 6.5 PSI)

<b>SYSP -</b>	<b>26 . 0</b>	<b>PSI</b>	
<b>OUTP -</b>	<b>3 . 0</b>	<b>PSI</b>	<b>LALR</b>
<b>FLOW -</b>	<b>5461</b>	<b>SCFD</b>	

*See section 13.9 for troubleshooting information.*

**8.5.4 High Flow Alarm –**

Occurs when the Flow Rate (**FLOW**) rises above the alarm set point for more than one (1) minute.  
(Default setting is 4500 SCFD)

<b>SYSP -</b>	<b>26 . 0</b>	<b>PSI</b>	
<b>OUTP -</b>	<b>10 . 0</b>	<b>PSI</b>	
<b>FLOW -</b>	<b>5461</b>	<b>SCFD</b>	<b>ALR</b>

*See section 13.11 for troubleshooting information.*

**8.5.5 High Humidity Alarm –**

Occurs when the Humidity level rises above the alarm set point for more than one (1) minute.  
(Default setting is 10.0%)

<b>HUMIDITY -</b>	<b>15 . 0%</b>	<b>ALR</b>
<b>OUT TMP -</b>	<b>71 . 3 °F</b>	
<b>WTR TMP -</b>	<b>72 . 5 °F</b>	
<b>WATER LVL -</b>		

If this alarm is present for one (1) minute or more, the air dryer will go into **SHUTDOWN** mode to prevent wet air from being sent to the supply line.

*See section 13.12 for troubleshooting information*

**8.5.6 High Out Temperature Alarm –**

Occurs when the outlet air temperature rises above 140°F for more than one (1) minute.

<b>HUMIDITY -</b>	<b>0 . 0%</b>	
<b>OUT TMP -</b>	<b>171 . 3 °F</b>	<b>ALR</b>
<b>WTR TMP -</b>	<b>72 . 5 °F</b>	
<b>WATER LVL -</b>		

If this alarm is present for one (1) minute or more, the air dryer will go into **SHUTDOWN** mode to protect against damage due to overheating.

*See section 13.14 for troubleshooting information.*

**8.5.7 High Water Temperature Alarm -**

Occurs when the water temperature rises above 140°F for more than one (1) minute.

HUMIDITY -	0.0%
OUT TMP -	71.3°F
WTR TMP -	172.5°F <b>ALR</b>
WATER LVL -	

If this alarm is present for one (1) minute or more, the air dryer will go into **SHUTDOWN** mode to protect against damage due to overheating.

*See section 13.19 for troubleshooting information.*

**8.5.8 High Water Alarm –**

Occurs when the Water level rises above the high-water sensor in the sight glass.

HUMIDITY -	0.0%
OUT TMP -	71.3°F
WTR TMP -	72.5°F
WATER LVL -	<b>HALR</b>

*See section 13.17 for troubleshooting information.*

**8.5.9 Low Water Alarm –**

Occurs when Water level drops below the low water sensor in the sight glass.

HUMIDITY -	0.0%
OUT TMP -	71.3°F
WTR TMP -	72.5°F
WATER LVL -	<b>LALR</b>

If this alarm is present for one (1) minute or more, the air dryer will go into **SHUTDOWN** mode to prevent damage to the compressor.

*See section 13.15 for troubleshooting information.*

**8.5.10 Compressor Run Alarm –**

Occurs when the compressor has reached 4,380 hours of run time, indicating a 6-month maintenance interval (approx.). Perform the next required maintenance.

SYSTEM STAT -	SHUTDOWN
COMP RUN -	4380HRS <b>ALR</b>
TOWER -	TWR1

## 8.6 Adjusting & Resetting Dryer Set Points

Dryer Set Points are simply limits programmed for a specific reading. Once this limit is reached (or exceeded) this results in an alarm for that reading. Each of these set points is factory programmed with a default value based on typical usage of the air dryer. Many of the set points for dryer alarms can be modified to levels more closely based upon your specific application.

- Press the Up (↑) Arrow Button to access the Set Point Adjust screens.
- Press the Up (↑) & Down (↓) Arrow Buttons to navigate through the available Set Point Adjust screens.
- If there is no activity for 2 minutes the display screen will return to normal operation.
- To change a specific Set Point:

### 8.6.1 High Flow Alarm Set Point (default setting is 4500 SCFD) –

- 8.6.1.1** Press the Right (→) Arrow Button to access the Change Value Screen.

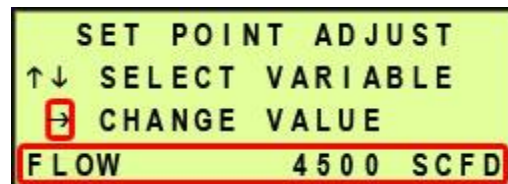

- 8.6.1.2** Press the Right (→) & Left (←) Arrow Buttons to move the underscore beneath the digit to change.

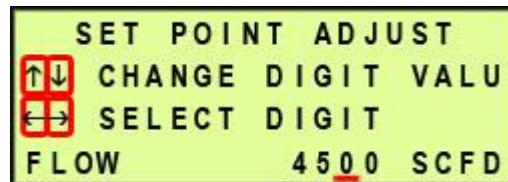

- 8.6.1.3** Press the Up (↑) & Down (↓) Arrow Buttons to change the value of the selected digit.

- 8.6.1.4** Press the Right (→) Arrow Button until the underscore disappears. This will lock in the new setting value.

**8.6.2 High Outlet Pressure Alarm Set Point** (default setting is 12.0 PSI) –

**8.6.2.1** Press the Right (→) Arrow Button to access the Change Value Screen.

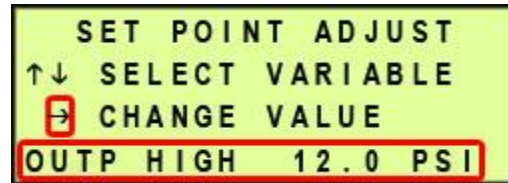

**8.6.2.2** Press the Right (→) & Left (←) Arrow Buttons to move the underscore beneath the digit to change.

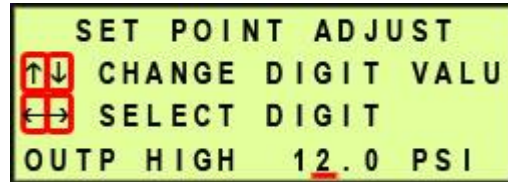

**8.6.2.3** Press the Up (↑) & Down (↓) Arrow Buttons to change the value of the selected digit.

**8.6.2.4** Press the Right (→) Arrow Button until the underscore disappears. This will lock in the new setting value.

**8.6.3 Low Outlet Pressure Alarm Set Point** (default setting is 6.5 PSI) –

**8.6.3.1** Press the Right (→) Arrow Button to access the Change Value Screen.

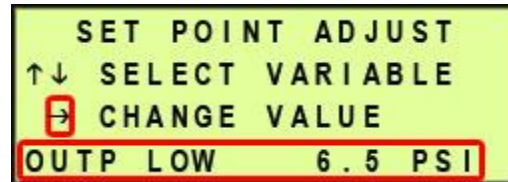

**8.6.3.2** Press the Right (→) & Left (←) Arrow Buttons to move the underscore beneath the digit to change.

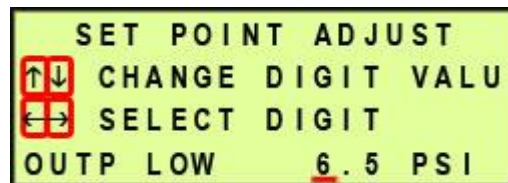

**8.6.3.3** Press the Up (↑) & Down (↓) Arrow Buttons to change the value of the selected digit.

**8.6.3.4** Press the Right (→) Arrow Button until the underscore disappears. This will lock in the new setting value.



**8.6.4 Low System Pressure Alarm Set Point** (default setting is 18.0 PSI) –

**8.6.4.1** Press the Right (→) Arrow Button to access the Change Value Screen.

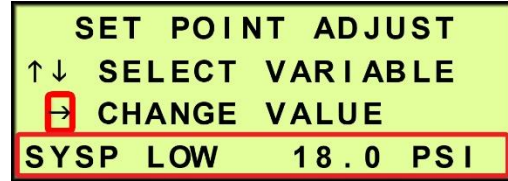

**8.6.4.2** Press the Right (→) & Left (←) Arrow Buttons to move the underscore beneath the digit to change.

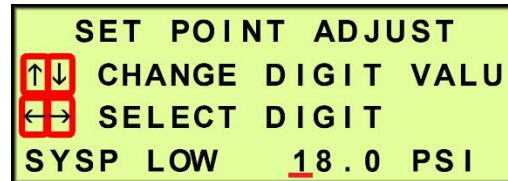

**8.6.4.3** Press the Up (↑) & Down (↓) Arrow Buttons to change the value of the selected digit.

**8.6.4.4** Press the Right (→) Arrow Button until the underscore disappears. This will lock in the new setting value.

**8.6.5 High Humidity Alarm Set Point** (default setting is 10.0%) –

**8.6.5.1** Press the Right (→) Arrow Button to access the Change Value Screen.

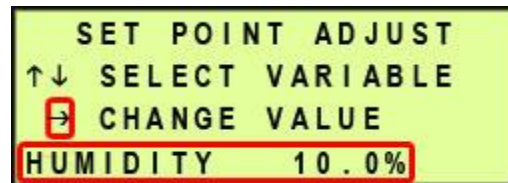

**8.6.5.2** Press the Right (→) & Left (←) Arrow Buttons to move the underscore beneath the digit to change.

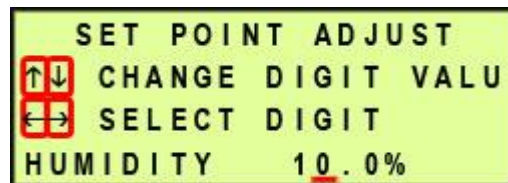

**8.6.5.3** Press the Up (↑) & Down (↓) Arrow Buttons to change the value of the selected digit.

**8.6.5.4** Press the Right (→) Arrow Button until the underscore disappears. This will lock in the new setting value.



**8.6.6 Power Up Delay Set Point** (default setting is 0 sec) –

The Power Up Delay keeps the compressor from turning on immediately when the dryer is powered on for up to 10 seconds. This allows multiple dryers to power on in separate intervals in case of a power loss.

**8.6.6.1** Press the Right (→) Arrow Button to access the Change Value Screen.

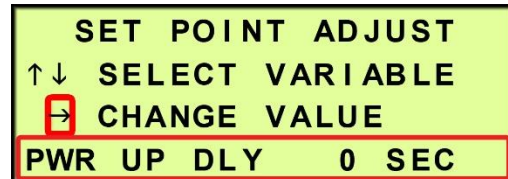

**8.6.6.2** Press the Right (→) & Left (←) Arrow Buttons to move the underscore beneath the digit to change.

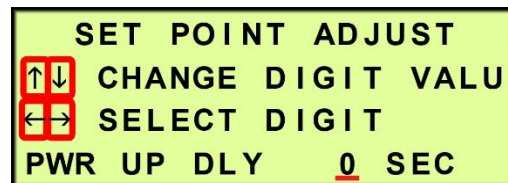

**8.6.6.3** Press the Up (↑) & Down (↓) Arrow Buttons to change the value of the selected digit.

**8.6.6.4** Press the Right (→) Arrow Button until the underscore disappears. This will lock in the new setting value.

**8.6.7 Compressor Total Hour Reset** –

**8.6.7.1** Press and Hold the Left (←) & Right (→) Arrow Buttons at the same time until the value resets to zero (0).

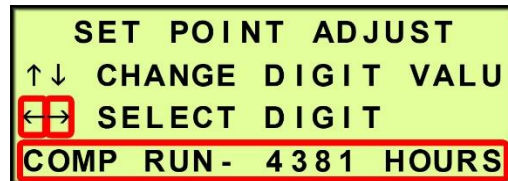
**8.6.8 Reset to Factory Values** –

**8.6.8.1** Press and Hold the Left (←) & Right (→) Arrow Buttons at the same time until screen flickers. This will signify the default values have reset.

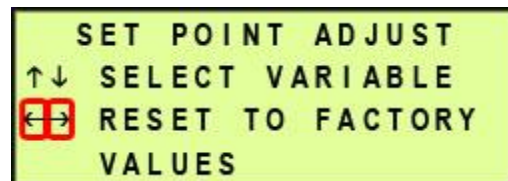

### 8.6.9 Alarm Delays Set Point

The Alarm Delay allows an alarm condition to be present for up to one (1) minute before signaling the alarm. This allows the dryer to come out of the alarm condition on its own without signaling an alarm.

**ON** (default) – waits one (1) minute before signaling alarms

**OFF** – signals alarms immediately

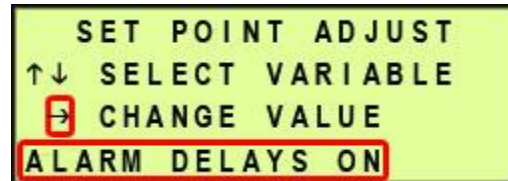

**8.6.9.1** Press the Right (→) Arrow Button to change the value.

### 8.6.10 Pressure Gauge –

This is an information screen only and will not time-out, returning to the cycling information screens. It also masks air dryer alarms while in use. This screen can be used during air dryer troubleshooting.

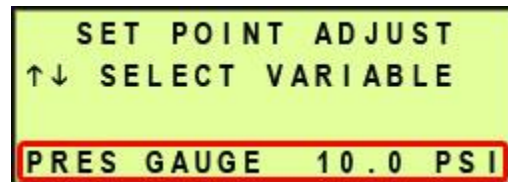

## 8.7 Opening Panels

### 8.7.1 Removing Top Cover –

**8.7.1.1** Depress the locking latches and pull the Top Cover off.



### 8.7.2 Removing Front Panel –

**8.7.2.1** Depress the locking latches and pull the Front Panel out.



## 8.8 Connecting to Common Alarm Terminals

**8.8.1** Remove Top Cover (see section 8.7.1 ).

**8.8.2** Connect the external wire pair to the Common Alarm terminals.

**NOTE:** There are two (2) redundant terminal blocks allowing multiple connections.

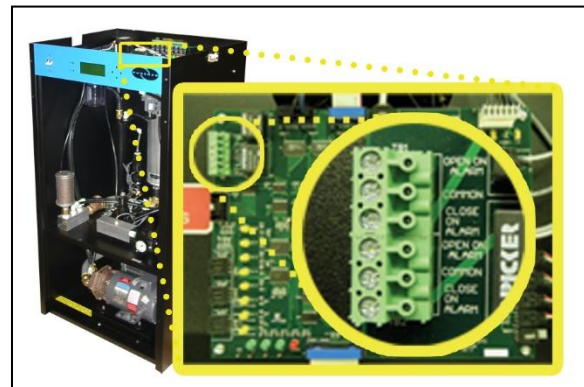

**8.8.3** Reinstall Top Cover.

## 8.9 Connecting to Discrete Alarm Terminals

- 8.9.1** Connect the external wire pair to the specific alarm terminal.



## 8.10 Depressurizing the Dryer

- 8.10.1** Remove Front Panel. ( see section 8.7.2 )

- 8.10.2** Push the Back Pressure Tube in and hold the green ferrule. While holding the ferrule pull the tube out.

- 8.10.3** To prevent pressure from building back up, power the dryer **OFF** (See 8.3 section for detail).

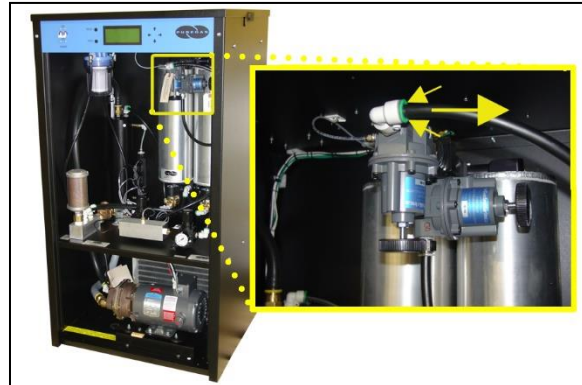

- 8.10.4** Reinstall Front Panel

## 8.11 Setting the System Pressure

**8.11.1** Set the System Pressure According to Elevation Chart Below:

**8.11.1.1** Set system pressure to within (+/- 0.5 PSI) per the elevation chart below. Setting above tolerance **WILL** lead to increased motor load which may lead to a tripped circuit breaker. Setting below tolerance may lead to higher humidity within the system.

SYSTEM PRESSURE AT VARIOUS ALTITUDES							
ELEVATION ABOVE SEA LEVEL(ft.)	0	2000	4000	6000	8000	10000	12000
BACK PRESSURE REGULATOR SETTING	25.0	24.0	23.0	22.0	21.0	20.0	19.0
BYPASS RELIEF VALVE SETTING	26.0	25.0	24.0	23.0	22.0	21.0	20.0

**8.11.1.2** When the Unit Screen (8.4.4.1 ) appears on the display, press the **HOLD Button** on the Front Panel to freeze that screen.

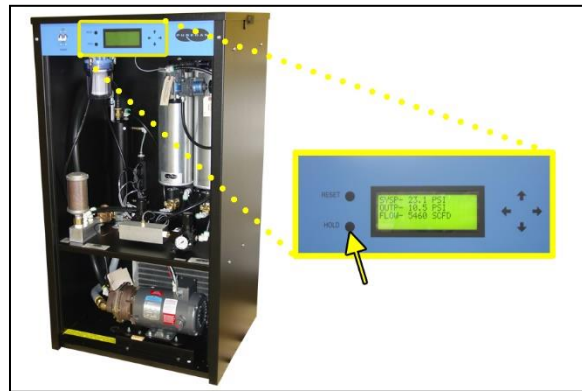

**8.11.1.3** Remove Front Panel. (see section 8.7.2 ).

**8.11.1.4** Unlock the knob on the Bypass and Back Pressure Valves by loosening the retaining nuts.

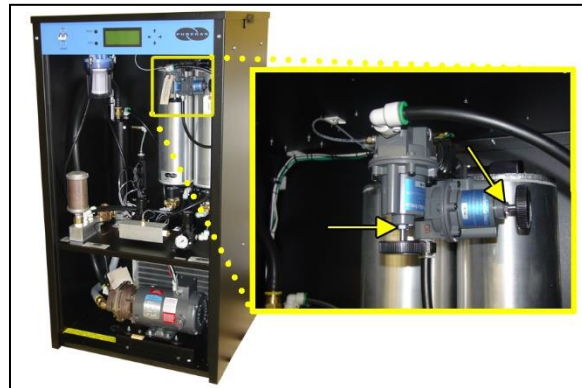

- 8.11.1.5** Turn the Bypass Valve Clockwise until it is completely closed.



- 8.11.1.6** Push the Back Pressure Tube in and hold the green ferrule. While holding the ferrule pull the tube out.

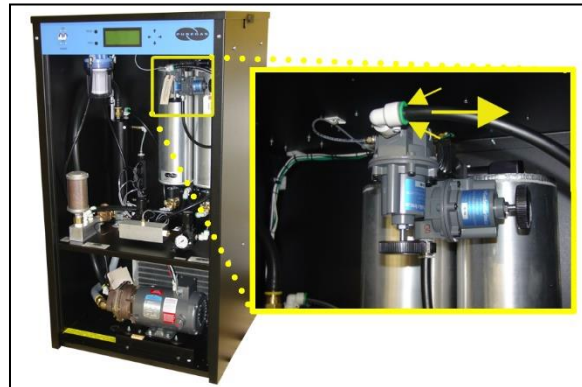

- 8.11.1.7** Adjust Back Pressure Valve until the **SYSP** reading on the front panel display is correct according to your elevation. (see chart 8.11.1 )

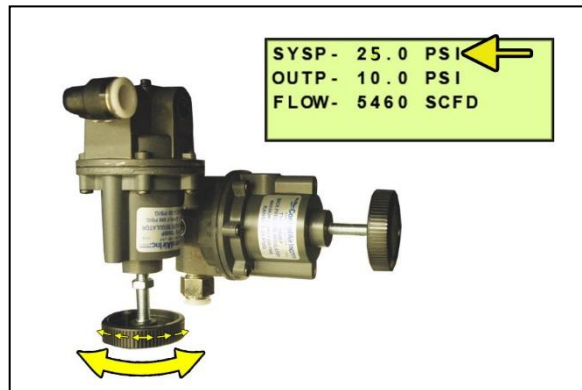

- 8.11.1.8** Reinstall Back Pressure Tube.

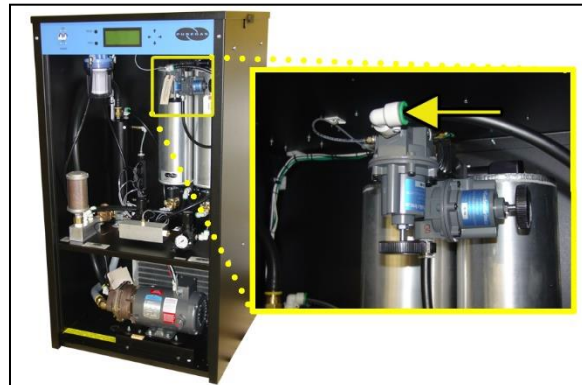



- 8.11.1.9** Open the Bypass Valve until the **SYSP** reading on the front panel display is correct according to your elevation.  
(see chart 8.11.1 )

- 8.11.1.10** Reinstall Front Panel.

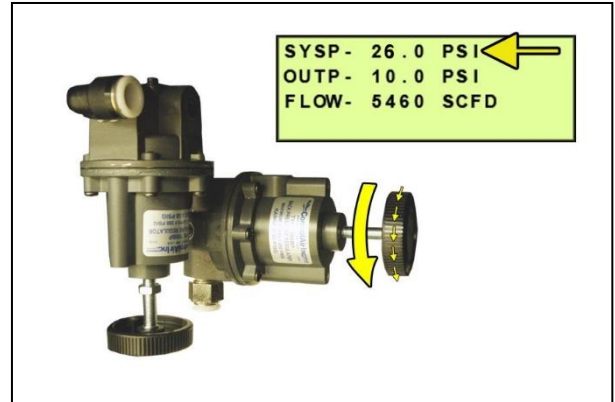

## 8.12 Setting the Static Pressure

- 8.12.1** Remove Front Panel. (see section 8.7.2 ).

- 8.12.2** Pull the Static Pressure Regulator Knob out.

- 8.12.3** Turn the knob until the reading on the pressure gauge is **17 PSI**.

- 8.12.4** Push knob in to lock.

- 8.12.5** Reinstall Front Panel.

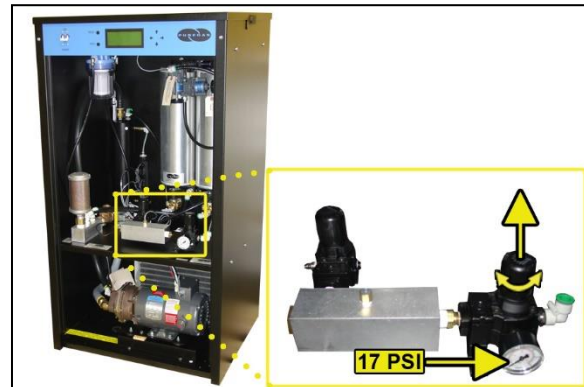

## 8.13 Setting the Outlet Pressure

**8.13.1** When the Unit Screen (8.4.4.1 ) appears on the display, press the **HOLD** Button on the Front Panel to freeze that screen.



**8.13.2** Remove Front Panel. (see section 8.7.2 ).

**8.13.3** Pull the Outlet Pressure Regulator knob out.

**8.13.4** Turn knob until Outlet Pressure (**OUTP**) reading is at the desired setting.

**8.13.5** Push knob in to lock

**8.13.6** Reinstall Front Panel.

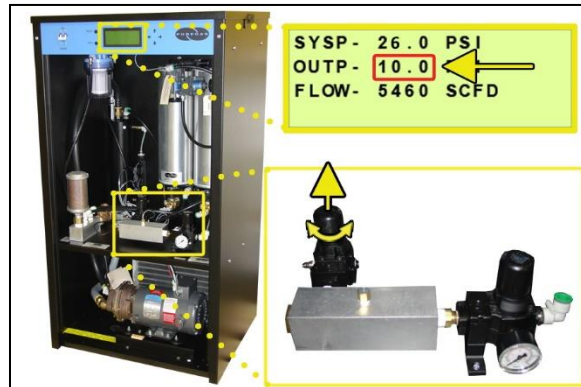



## 9. Testing Your Dryer

### 9.1 Safety & Warning Information



#### **WARNING!**

**Extreme care should be exercised to avoid contact with live electrical circuits.** Many procedures performed during installation, operation, testing, and maintenance of this air dryer require the equipment to be running, creating a situation for potential electrical shock. It is highly recommended that you remove all jewelry before performing any procedures.



#### **WARNING!**

**Internal surfaces may be hot.** Use care when coming into contact with internal components as there is a potential for some of these components to become hot when in operation or standby.



#### **WARNING!**

**High Noise.** ALTECAIR air dryers are meant to be installed in an unattended area.



#### **CAUTION!**

Depressurizing the air dryer may be necessary before performing certain procedures. **NEVER** remove pressure sensing tubes from the Control Board without depressurizing the air dryer first, or **damage to the Control Board will occur.**

**CAUTION!**

This Air Dryer does not contain an internal Surge Protection Device (SPD). If an SPD is required, it must be supplied by the user.

**CAUTION!**

**DO NOT USE DISTILLED OR DE-IONIZED WATER IN THIS UNIT.** It will cause damage to the compressor and other major components over time. This unit is designed for **clean tap water only**.

**CAUTION!**

Observe precautions for handling **Electrostatic Sensitive Devices**.

**IMPORTANT!**

Installation of ALTECAIR air dryers are intended for network telecommunication facilities (non-customer premises) only.

## 9.2 Measuring Compressor Amp Draw



### **WARNING!**

**Internal surfaces may be hot.** Use care when coming into contact with internal components as there is a potential for some these components to become hot when in operation or standby.

#### **With the Power ON:**

**9.2.1** Remove Front Panel (see section 8.7.2 ).

**9.2.2** Locate the Power Connector for the compressor.

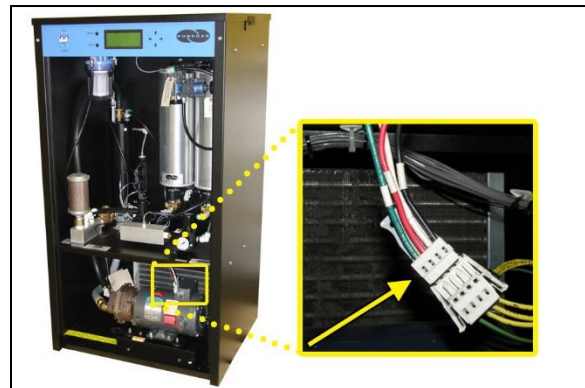

**9.2.3** Use an Amp Meter to measure the running amps for each wire to compressor.

See chart for proper amperage for each wire.

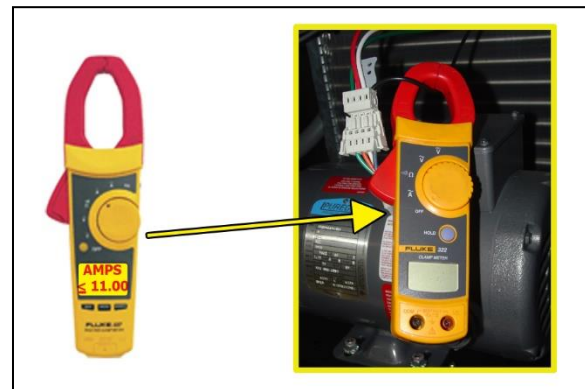

	Wire No.	Color	Amps (MAX)
<b>P10KW</b>	15	Black	11.0
<b>P15KW</b>	15	Black	9.00

**9.2.4** Reinstall Front Panel.

*If the compressor amps measure over value in the chart, see section 13.20 for troubleshooting information.*

### 9.3 Measuring Voltage to Compressor



#### **WARNING!**

**Extreme care should be exercised to avoid contact with live electrical circuits.** It is highly recommended that you remove all jewelry before performing any procedures.

**With power ON:**

**9.3.1** Remove Front Panel. (see section 8.7.2 ).

**9.3.2** Locate the power connector for the compressor.

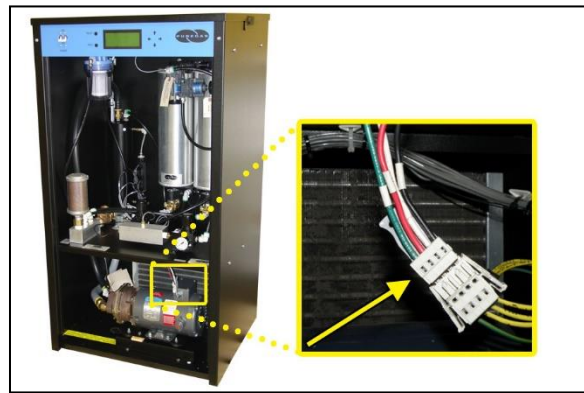

**9.3.3** Use a Voltmeter to measure the voltage.

Place the probes inside the connector windows to make contact with the connector pins.

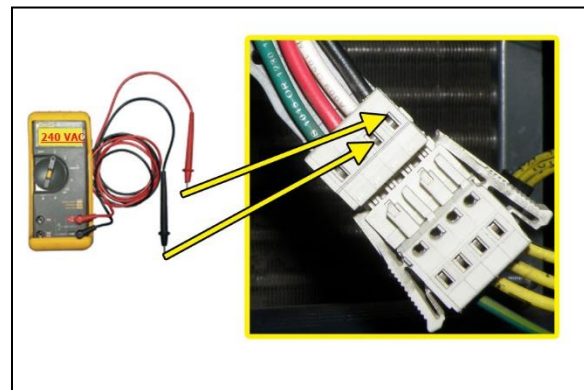

	From		To		Voltage
	Wire No.	Color	Wire No.	Color	
<b>P10KW</b>	15	Black	16	White	230 VAC +/- 10%
	15	Black	16	White	208 VAC +/- 10%
<b>P15KW</b>	15	Black	17	Red	208 VAC +/- 10%
	16	White	17	Red	208 VAC +/- 10%

**9.3.4** Reinstall Front Panel.

## 9.4 Measuring Incoming Voltage



### **WARNING!**

**Extreme care should be exercised to avoid contact with live electrical circuits.** It is highly recommended that you remove all jewelry before performing any procedures.

- 9.4.1** Remove the Top Cover to locate the POWER Circuit Breaker in the Top Section of the air dryer.

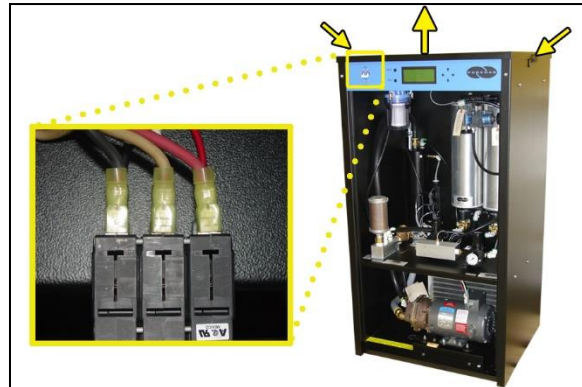

- 9.4.2** Use a Voltmeter to measure the voltage:

- 9.4.2.1** Place the probes between the Circuit Breaker and terminal insulation so that they touch the metal contacts.

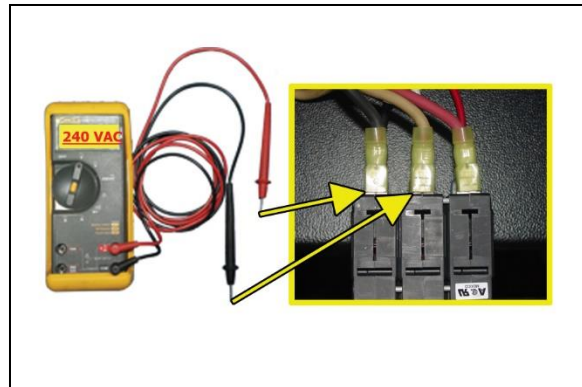

The voltage should measure **208 or 230 VAC +/- 10%**.

- 9.4.3** Reinstall Top Cover.

## 9.5 Testing High Outlet Pressure Alarm

**NOTE:** All testing values are based on default Dehydrator settings, if settings have been changed, adjust testing values accordingly. Reference the Appendix Section 14.2 for Limits and Defaults.

**9.5.1** When the Unit Screen (8.4.4.1 ) appears on the display, press the **HOLD** Button on the Front Panel to freeze that screen.

**9.5.2** Make a note of the current Outlet Pressure (**OUTP**) reading.



**9.5.3** Remove Front Panel (see section 8.7.2 ).

**9.5.4** Pull the Outlet Pressure Regulator knob out.

**9.5.5** Turn knob clockwise until Outlet Pressure (**OUTP**) reading climbs **over 12.0 PSI**.

After one (1) minute, the High-Pressure Alarm should appear on the display.

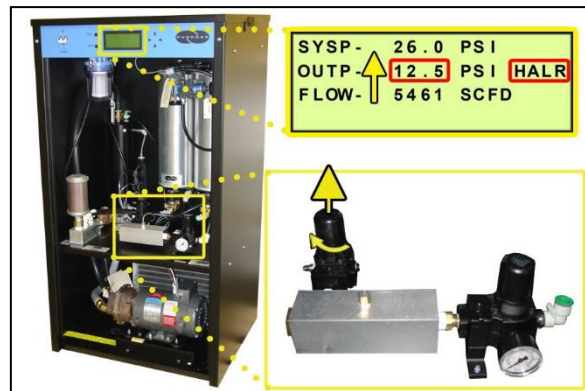



- 9.5.6** Turn Outlet Pressure Regulator knob counterclockwise until Outlet Pressure (**OUTP**) reading lowers to the reading recorded in step 9.5.2

- 9.5.7** Push knob in to lock.

- 9.5.8** Press the **RESET Button**.

- 9.5.9** Reinstall Front Panel.

*If you are unable to create a High Outlet Pressure Alarm as described, see section 13.8 for troubleshooting information.*

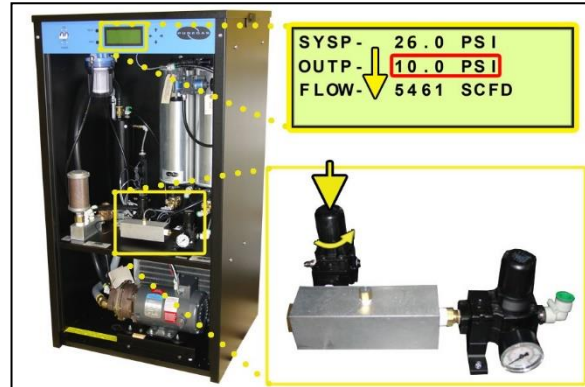

## 9.6 Testing Low Outlet Pressure Alarm

- 9.6.1** When the Unit Screen (8.4.4.1 ) appears on the display, press the **HOLD Button** on the Front Panel to freeze that screen.

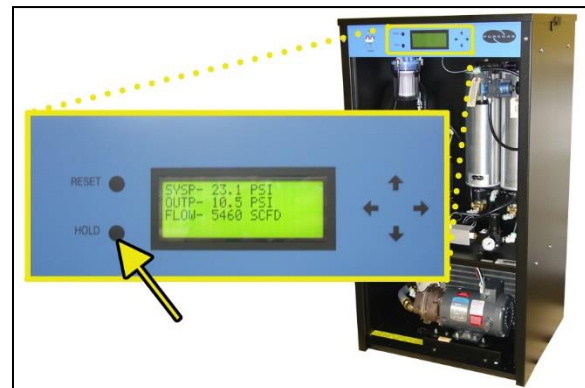

- 9.6.2** Make a note of the current Outlet Pressure (**OUTP**) reading.

- 9.6.3** Remove Front Panel (see section 8.7.2 ).

- 9.6.4** Pull the Outlet Pressure Regulator knob out.

- 9.6.5** Turn knob counterclockwise until Outlet Pressure (**OUTP**) reading drops **below 6.5 PSI**.

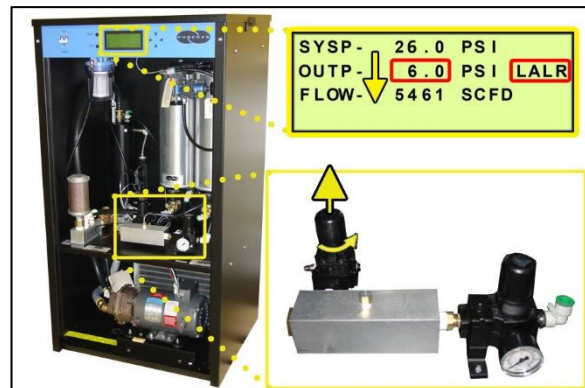

After one (1) minute, the Low-Pressure Alarm should appear on the display.

**9.6.6** Turn Outlet Pressure

Regulator knob clockwise  
until Outlet Pressure  
(**OUTP**) reading rises to the  
reading recorded in step 9.6.2

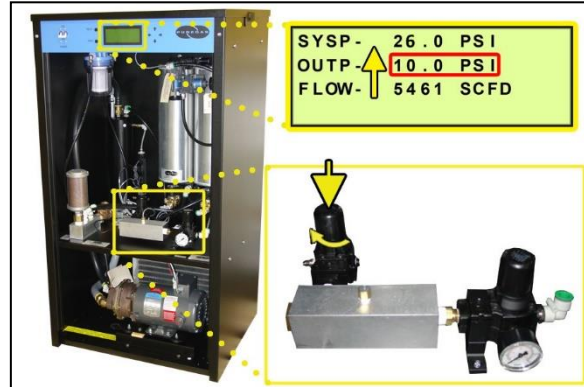
**9.6.7** Push knob in to lock.**9.6.8** Press the **RESET Button**.**9.6.9** Reinstall Front Panel.

*If you are unable to create a Low Outlet Pressure Alarm as described, see section 13.10 for troubleshooting information.*

**9.7 Testing Low System Pressure Alarm****9.7.1** When the Unit Screen

(8.4.4.1 ) appears on the  
display, press the **HOLD**  
**Button** on the Front Panel to  
freeze that screen.

**9.7.2** Make a note of the current  
System Pressure (**SYSP**)  
reading.

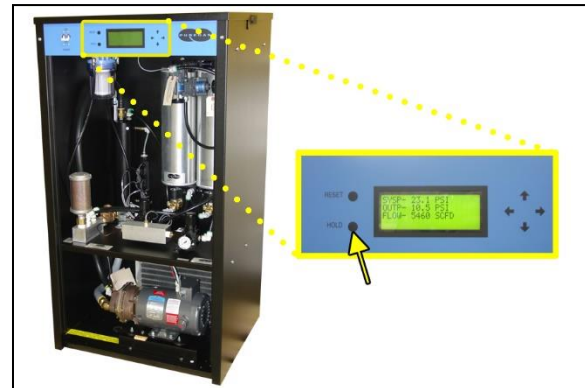

**9.7.3** Remove Front Panel (see section 8.7.2 ).



**9.7.4** Unlock the knob on the Bypass Valve by loosening the retaining nut.



**9.7.5** Turn the Bypass Valve counterclockwise until System Pressure (SYSP) reading drops **below 18.0 PSI**.

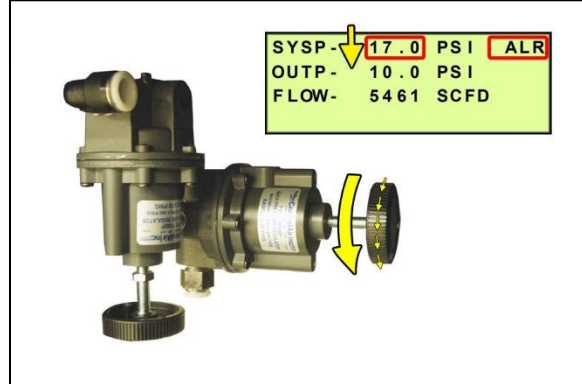

After one (1) minute, the Low System Pressure Alarm should appear on the display.

**9.7.6** Turn the Bypass Valve clockwise until System Pressure (SYSP) reading rises to the reading recorded in step 9.7.2

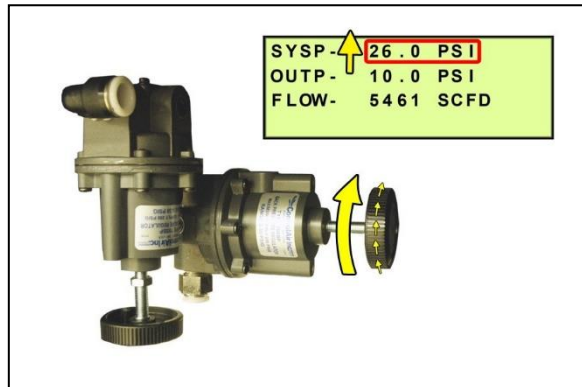

**9.7.7** Press the **RESET** Button.

**9.7.8** Reinstall Front Panel.

*If you are unable to create a Low System Pressure Alarm as described, see section 13.6 for troubleshooting information.*

## 9.8 Testing Consistent Heatless Dryer Cycling

**9.8.1** Remove Front Panel (see section 8.7.2 ).

**9.8.2** Disconnect the purge tubes from the Heatless Dryer.



**9.8.3** Place your hand beneath the purge fittings to feel for purging air. Air should:

- Purge from Tower 1 side
- **30 Seconds** later
- Purge from Tower 2 side
- **30 Seconds** later
- Purge from Tower 1 side
- **30 Seconds** later
- ...and so on.

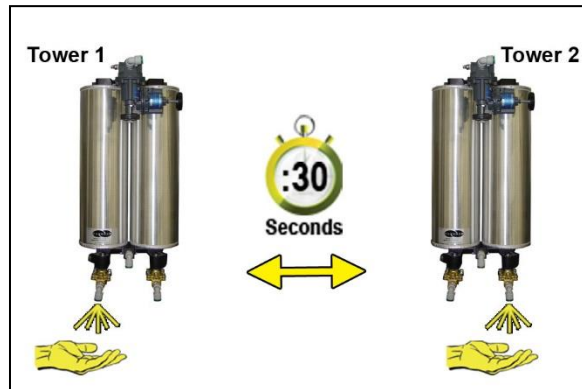

**9.8.4** Re-connect the purge tubes to the Heatless Dryer.

**9.8.5** Reinstall Front Panel.



## 9.9 Measuring Heatless Dryer Solenoid Voltage

**9.9.1** Remove Top Cover (see section 8.7.1 ).

**9.9.2** Locate the Heatless Dryer power terminals on Power Relay Board.

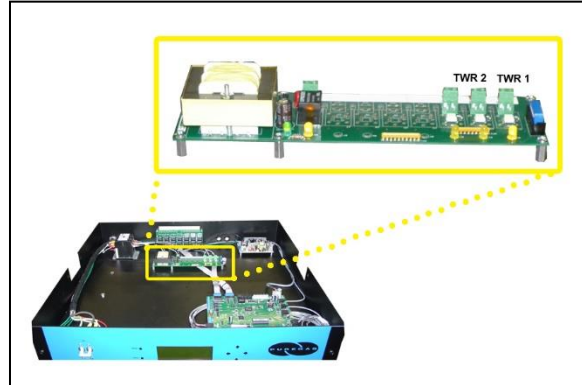

**9.9.3** Use a Voltmeter to measure the DC voltage across each set of “Tower” terminals.

Wire # 53 **BLK** & #22 **WHT** for Tower1.

Wire # 54 **BLK** & #23 **WHT** for Tower 2.

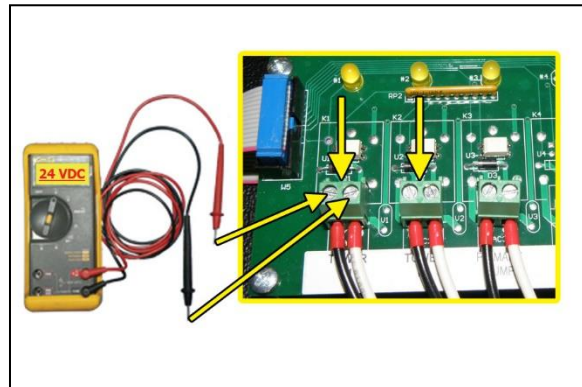

Continue to measure for up to 45 seconds if no voltage is initially measured.

The voltage should measure **24 Volts DC**.

**9.9.4** Reinstall Top Cover.

## 9.10 Testing Precooler Fan

- 9.10.1** Place your hand next to the Precooler Fan to feel for air being blown outwards.



*If fan is not blowing air outwards as described:*

- Check for loose wiring. Refer to the Wiring Diagram (section 14.1 )
- Replace defective fan (see sections 11.4 for part location and 11.7 for ordering information).

## 9.11 Testing Low Water Sensor Function & System Shutdown

- 9.11.1** When the Temperature Screen (8.4.4.2 ) appears on the display, press the **HOLD** Button on the Front Panel to freeze that screen.

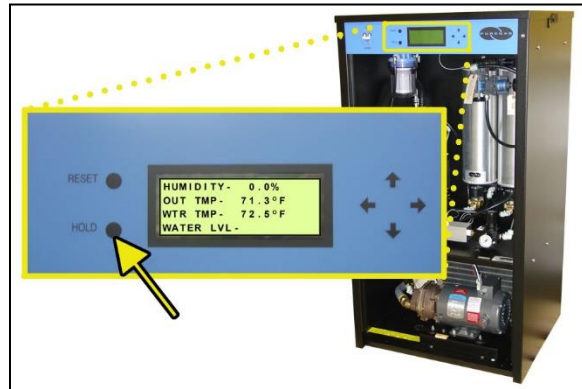

- 9.11.2** Remove Front Panel (see section 8.7.2 ).

- 9.11.3** Locate and disconnect the Low Water Sensor Connector.

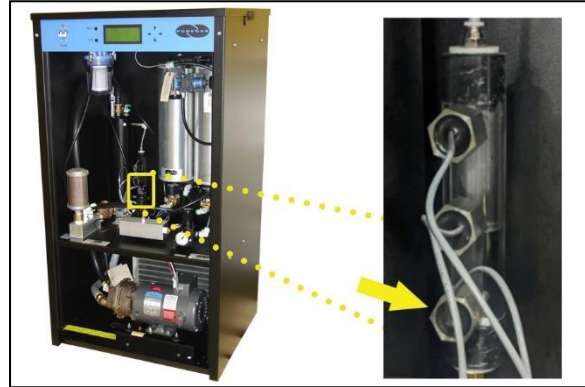

- 9.11.4** After one (1) minute verify that the Low Water Level Alarm appears, and System goes into **SHUTDOWN** mode.

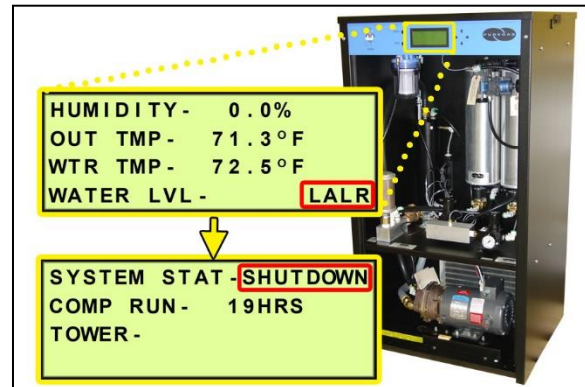

- 9.11.5** Reconnect the Low Water Sensor Connector.

- 9.11.6** Press the **RESET Button**.

- 9.11.7** Reinstall Front Panel.

*If you are unable to create a Low Water Level / Shutdown alarm as described, see section 13.16 for troubleshooting.*

## 9.12 Testing Dump Water Sensor Function

- 9.12.1** Remove Front Panel (see section 8.7.2 ).

- 9.12.2** Press down on the quick disconnect fitting collar to remove the inlet manifold assembly. Set the inlet manifold assembly to the side.

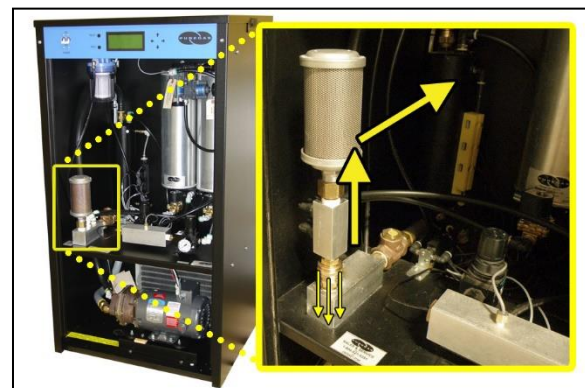



**9.12.3** Slowly add water in dryer.

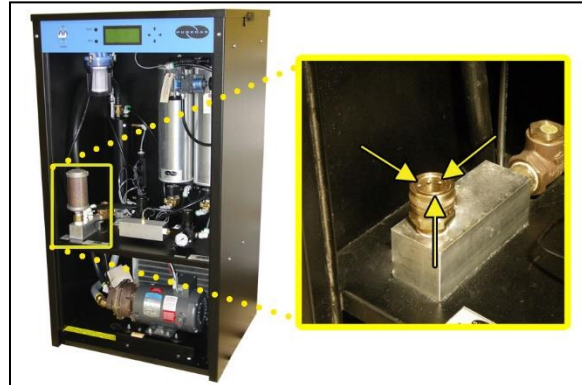

**9.12.4** Keep adding water until the water level is above the Dump Water Sensor and the LED on the control board on the upper shelf is lit.

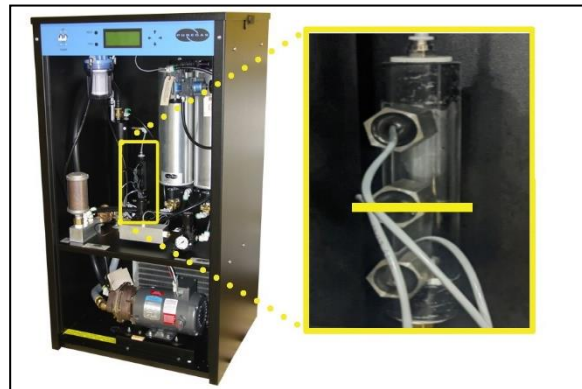

**9.12.5** The dryer will dump the water until it stabilizes just below the Dump Water Sensor, and the LED on the control board will turn off.

**9.12.6** Reinstall the inlet manifold assembly by pressing down on the quick disconnect fitting collar and inserting male coupling fitting.

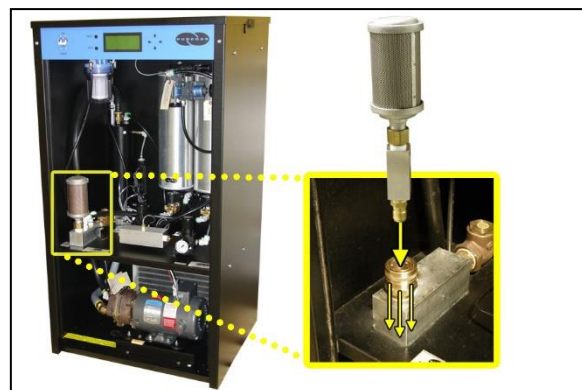

**9.12.7** Reinstall Front Panel.

## 9.13 Testing High Water Sensor Function

**9.13.1** When the Temperature Screen (8.4.4.2 ) appears on the display, press the **HOLD Button** on the Front Panel to freeze that screen.

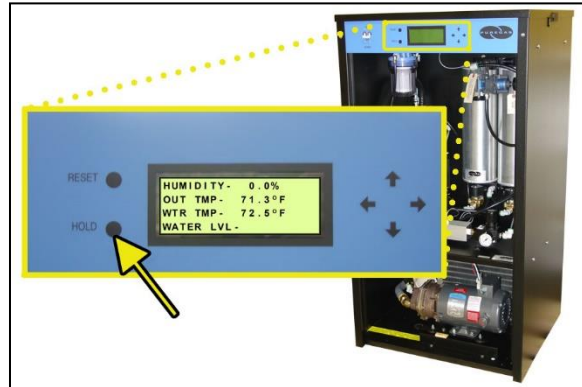

**9.13.2** Remove Front Panel (see section 8.7.2 ).

**9.13.3** Press down on the quick disconnect fitting collar to remove the inlet manifold assembly. Set the inlet manifold assembly to the side.

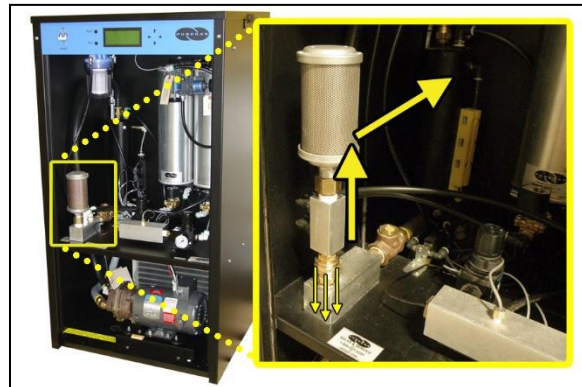

**9.13.4** Slowly add water in dryer.

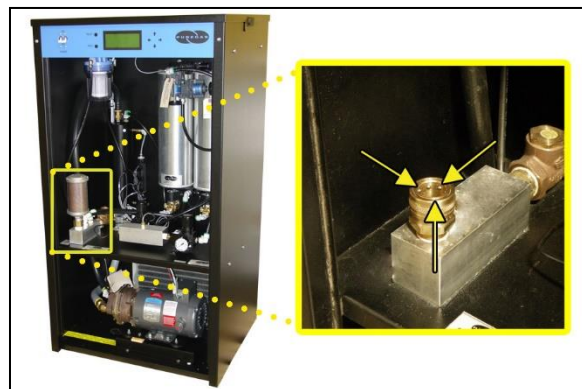

**9.13.5** Keep adding water until the water level is above the High-Water Sensor

**9.13.6** After one (1) minute verify that the High-Water Level Alarm appears.



**9.13.7** The dryer will dump the water until it stabilizes just below the Dump Water Sensor, and the High LED on the control board on the upper shelf will turn off.

**9.13.8** Reinstall the inlet manifold assembly by pressing down on the quick disconnect fitting collar and inserting male coupling fitting.

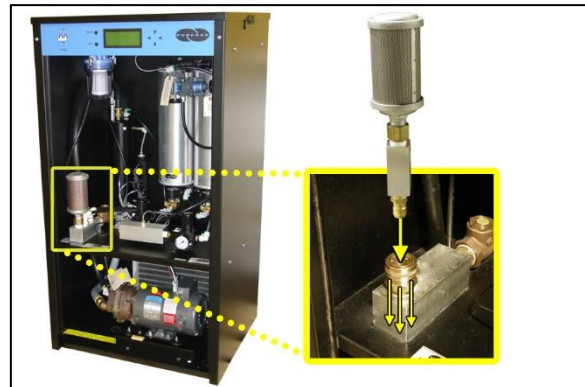

**9.13.9** Press the **RESET Button**.

**9.13.10** Reinstall Front Panel.

*If you are unable to create a High-Water Level alarm as described, see section 13.18 for troubleshooting.*



## 9.14 Testing Water Dump Solenoid Valve

**9.14.1** Remove Front Panel (see section 8.7.2 ).

**9.14.2** Remove Top Cover (see section 8.7.1 ).

**9.14.3** Press down on the quick disconnect fitting collar to remove the inlet manifold assembly.

Set the inlet manifold assembly to the side.

**9.14.4** Slowly add water in dryer.

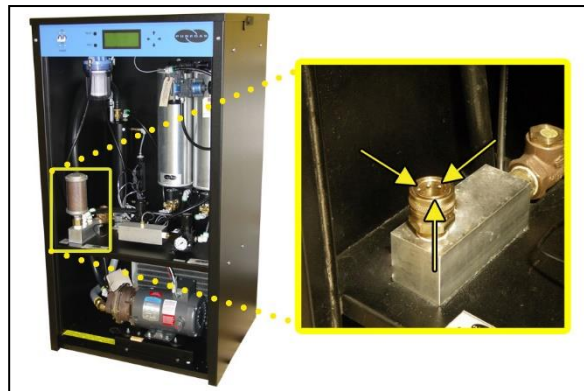
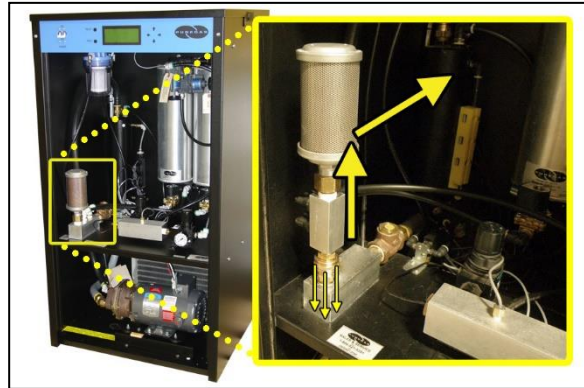

**9.14.5** Keep adding water until the water level is above the Dump Water Sensor.

**9.14.6** Measure voltage to Dump Solenoid while dryer is dumping water.

Wire # 51 **BLK** & #52 **WHT**  
for Tower1

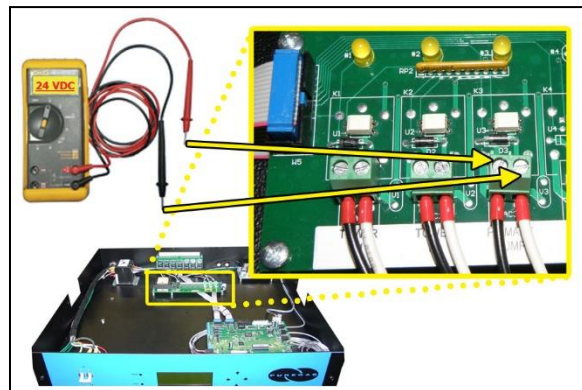

Voltage should be **24 Volts DC**.

**9.14.7** Dryer will dump the water until the water level is just below the Dump Water Sensor.

**9.14.8** Reinstall the inlet manifold assembly by pressing down on the quick disconnect fitting collar and inserting male coupling fitting.

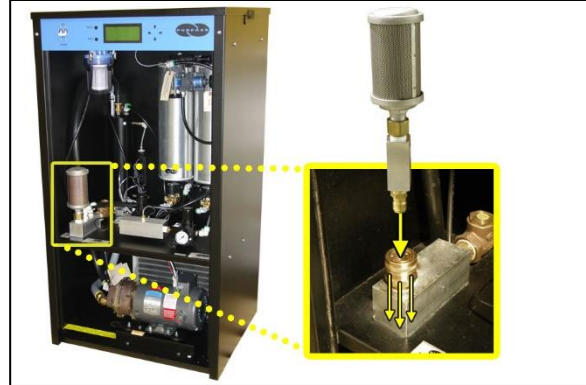

**9.14.9** Reinstall Front Panel.

**9.14.10** Reinstall Top Cover.

**9.14.11**

## 9.15 Testing Humidity Alarm and System Shutdown

**9.15.1** Power the Dryer **OFF**.

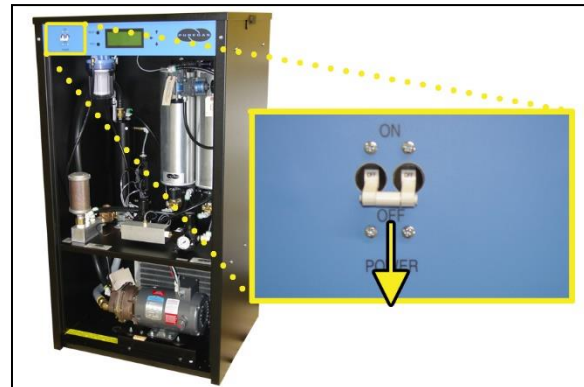

**9.15.2** Remove Front Panel (see section 8.7.2 ).

**9.15.3** Depressurize the dryer by pushing the Back Pressure Tube in and hold the green ferrule. While holding the ferrule pull the tube out.



**9.15.4** Connect the tube back to the Back Pressure Regulator.

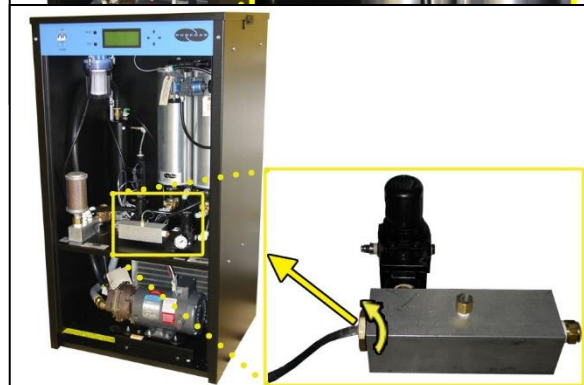

**9.15.5** Unscrew and remove the Humitter from the Combo Block.

**9.15.6** Power the Dryer **ON**.

The Humidity reading will begin to rise until it is over 10.0%.

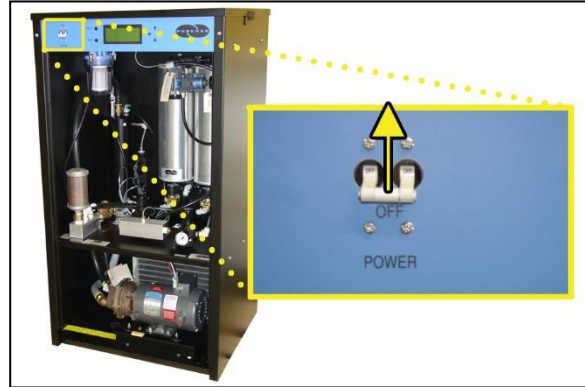

**9.15.7** When the Temperature Screen (8.4.4.2 ) appears on the display, press the **HOLD** Button on the Front Panel to freeze that screen.

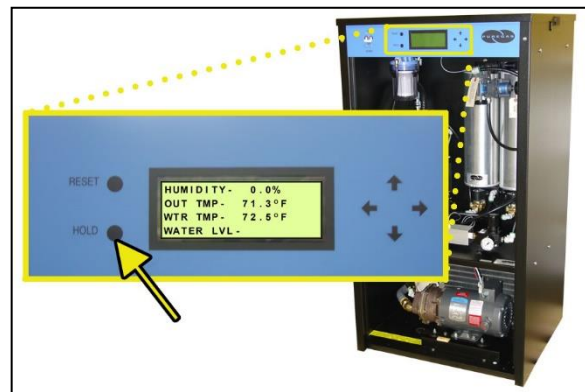

**9.15.8** After three (3) minutes, verify that a Humidity Alarm appears, and System goes into **SHUTDOWN** mode.

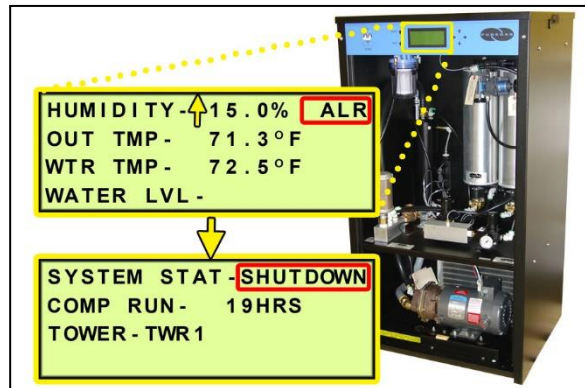

**9.15.9** Replace the Humitter into the Combo Block.

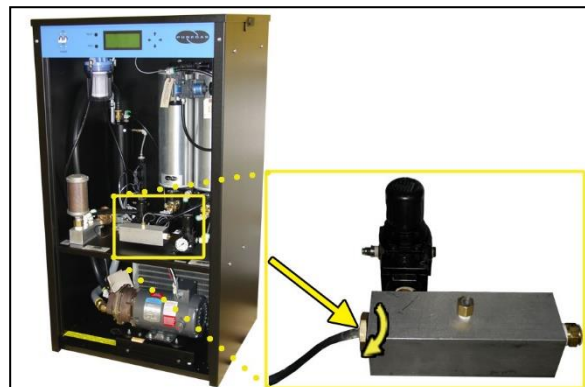

**9.15.10** Press the **RESET** Button to clear the Humidity alarm.

**9.15.11** Reinstall Front Panel.

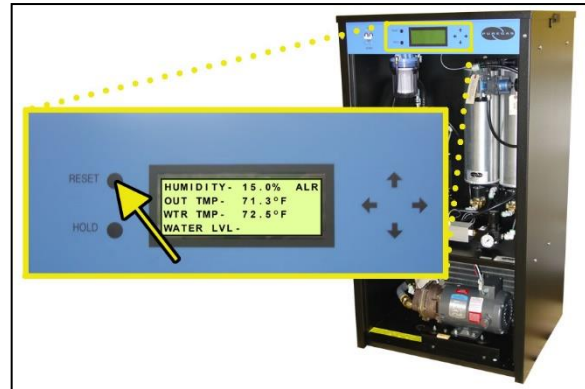

*If you are unable to create a Humidity / Shutdown alarm as described, see section 13.13 for troubleshooting information.*

## 9.16 Testing Fittings & Hoses for Leaks

**9.16.1** Visually inspect for water leaks.

**9.16.2** Check for air leaks:

**NOTE:** This is a general procedure that can be applied to any fitting or hose that has air pressure in it. **DO NOT SOAP TEST THE HUMITTER FITTING. DAMAGE TO THE HUMITTER MAY OCCUR.**

**9.16.2.1** Listen for any 'hissing' sounds which may indicate a fitting or hose air leak.

**9.16.2.2** Use a 1-inch paint brush to dab soapy water on the air fitting or hose connection to be tested.

If air bubbles appear at the connection, this indicates that air is leaking from the connection



*If any leaks are detected, take steps to seal them off (as necessary):*

- *Tighten the fitting*
- *Re-connect the hose end*
- *Replace the fitting / hose / component*

## 10. Maintaining Your Dryer

In order to ensure that your P10KW / P15KW Air Dryer continues to operate efficiently and reliably, ALTEC AIR recommends performing the following maintenance procedures at the specified Six-Month intervals.

It is also recommended that you print out the included *Six-Month Maintenance (section 10.2)* log sheet and record all completed maintenance for historical tracking and reference purposes.

The log sheet includes a Section reference column which indicates the User's Guide section containing the information about the specific procedure. Please refer to these sections for detailed procedural information.

**NOTE:** When operating at higher ambient temperatures, it is recommended that maintenance be performed more frequently.

### 10.1 Safety & Warning Information



#### **WARNING!**

**Extreme care should be exercised to avoid contact with live electrical circuits.** Many procedures performed during installation, operation, testing, and maintenance of this air dryer require the equipment to be running, creating a situation for potential electrical shock. It is highly recommended that you remove all jewelry before performing any procedures.



**WARNING!**

**Internal surfaces may be hot.** Use care when coming into contact with internal components as there is a potential for some of these components to become hot when in operation or standby.

**WARNING!**

**High Noise.** Altec AIR air dryers are meant to be installed in an unattended area.

**CAUTION!**

Depressurizing the air dryer may be necessary before performing certain procedures. **NEVER** remove pressure sensing tubes from the Control Board without depressurizing the air dryer first, or **damage to the Control Board will occur.**

**CAUTION!**

**SHUT DOWN IMMEDIATELY FOR REPAIRS** if the air compressor(s) shows any evidence of overheating or presents excessive noise.

**CAUTION!**

Observe precautions for handling **Electrostatic Sensitive Devices.**

**IMPORTANT!**

After performing any maintenance, always soap test pressure fittings to check for air leaks. Also, check for any loose or disconnected wiring.

## 10.2 Six Month Maintenance

MODEL: \_\_\_\_\_

LOCATION NAME: \_\_\_\_\_

SERIAL NUMBER: \_\_\_\_\_

ADDRESS: \_\_\_\_\_

DATE INSTALLED: \_\_\_\_\_

Procedure	Section	Maintenance Interval (Months)				
		6	12	18	24	30
Install Six Month Maintenance Kit <b>P011297</b>	11.6	<input type="checkbox"/>	<input type="checkbox"/>	<input type="checkbox"/>	<input type="checkbox"/>	<input type="checkbox"/>
Read & Record Flow Rate ( <b>FLOW</b> )	8.4.4.1					
Measure & Record Compressor Amp Draw	9.2					
Measure & Record Incoming Voltage (must be 208 or 230 VAC +/- 10%)	0					
Test High & Low Outlet Pressure Alarms	9.5 & 9.6	<input type="checkbox"/>	<input type="checkbox"/>	<input type="checkbox"/>	<input type="checkbox"/>	<input type="checkbox"/>
Test Low System Pressure Alarm	9.7	<input type="checkbox"/>	<input type="checkbox"/>	<input type="checkbox"/>	<input type="checkbox"/>	<input type="checkbox"/>
Set System Pressure	8.11	<input type="checkbox"/>	<input type="checkbox"/>	<input type="checkbox"/>	<input type="checkbox"/>	<input type="checkbox"/>
Set Static Pressure	8.12	<input type="checkbox"/>	<input type="checkbox"/>	<input type="checkbox"/>	<input type="checkbox"/>	<input type="checkbox"/>
Set Outlet Pressure	8.13	<input type="checkbox"/>	<input type="checkbox"/>	<input type="checkbox"/>	<input type="checkbox"/>	<input type="checkbox"/>
Test Consistent Heatless Dryer Cycling	9.8	<input type="checkbox"/>	<input type="checkbox"/>	<input type="checkbox"/>	<input type="checkbox"/>	<input type="checkbox"/>
Test Precooler Fan	9.10	<input type="checkbox"/>	<input type="checkbox"/>	<input type="checkbox"/>	<input type="checkbox"/>	<input type="checkbox"/>
Test Low Water Sensor Function & System Shutdown	9.11	<input type="checkbox"/>	<input type="checkbox"/>	<input type="checkbox"/>	<input type="checkbox"/>	<input type="checkbox"/>
Test Dump Water Sensor Function	9.12	<input type="checkbox"/>	<input type="checkbox"/>	<input type="checkbox"/>	<input type="checkbox"/>	<input type="checkbox"/>
Test High Water Sensor Function	9.13	<input type="checkbox"/>	<input type="checkbox"/>	<input type="checkbox"/>	<input type="checkbox"/>	<input type="checkbox"/>
Test Water Dump Solenoid Valve	9.14	<input type="checkbox"/>	<input type="checkbox"/>	<input type="checkbox"/>	<input type="checkbox"/>	<input type="checkbox"/>
Test Humidity Alarm & System Shutdown	9.15	<input type="checkbox"/>	<input type="checkbox"/>	<input type="checkbox"/>	<input type="checkbox"/>	<input type="checkbox"/>
Test Air Fittings for Leaks & Check for Water Leaks	9.16	<input type="checkbox"/>	<input type="checkbox"/>	<input type="checkbox"/>	<input type="checkbox"/>	<input type="checkbox"/>
Clean Precooler Coils		<input type="checkbox"/>	<input type="checkbox"/>	<input type="checkbox"/>	<input type="checkbox"/>	<input type="checkbox"/>
Visually Inspect Inside & Outside of Unit for Loose Wiring or Hardware		<input type="checkbox"/>	<input type="checkbox"/>	<input type="checkbox"/>	<input type="checkbox"/>	<input type="checkbox"/>
<b>Maintenance Performed by:</b>						
<b>Date of Maintenance:</b>						

**NOTE: COPY OR PRINT THIS PAGE AND KEEP IT WITH THE AIR DRYER**



## 11. Replacement Parts & Accessories

### 11.1 Top Section Parts

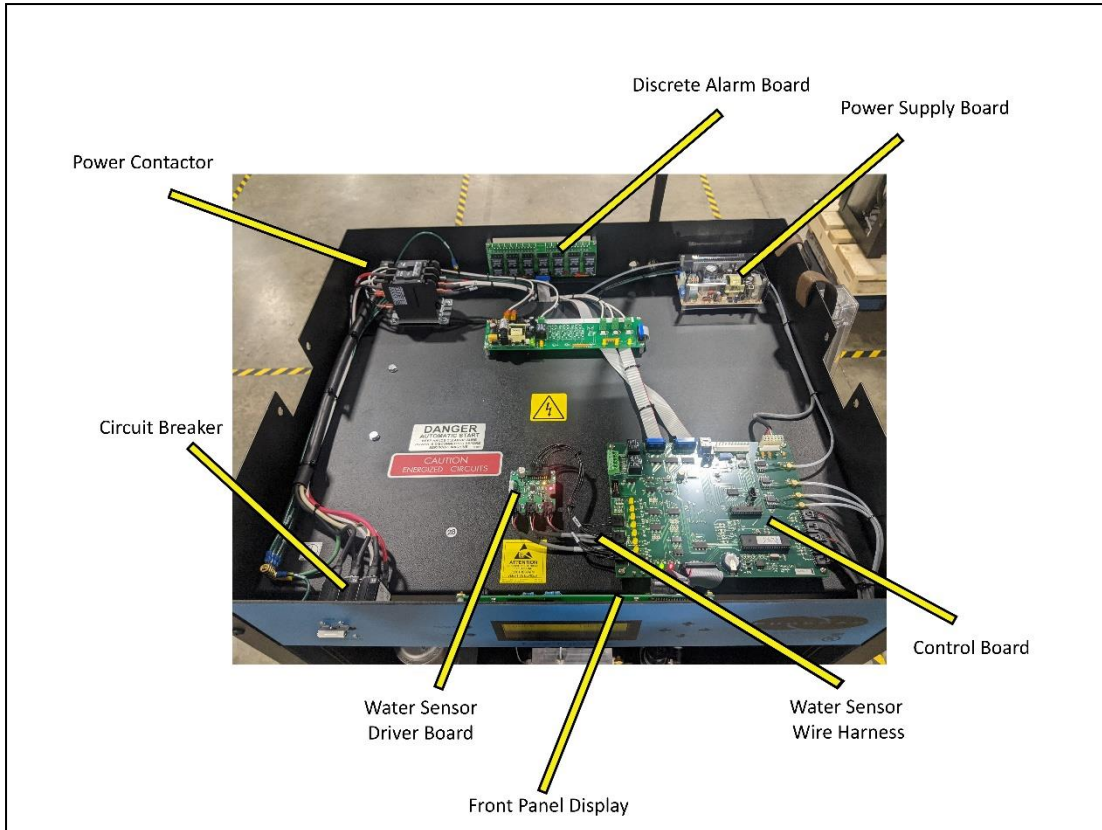

Description	Part Number	Quantity	Recommend Spare
Power Contactor	P011355	1	✓ (1)
Power Relay Board	P011140F1	1	✓ (1)
Circuit Breaker	P011376	1	✓ (1)
Front Panel Display	P011195	1	
Discrete Alarm Board	P010525	1	
Power Supply Board	P011372	1	
Control Board (w/ Eprom)	P013242	1	✓ (1)
Water Sensor Driver Board	P017913	1	
Water Sensor Wire Harness	P018260	1	

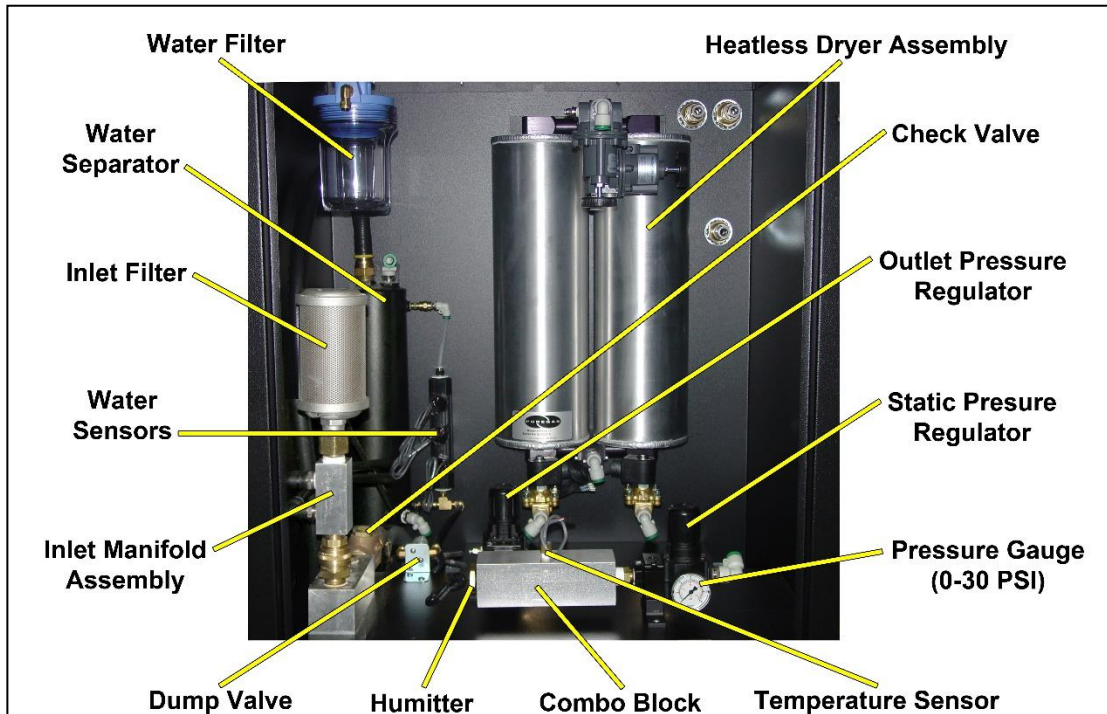

## 11.2 Middle Section Parts

Description	Part Number	Quantity	Recommend Spare
Water Filter	<i>In Kit P011297. See section 11.6 for detail.</i>		
Water Separator	P011139	1	
Inlet Filter	<i>In Kit P011297. See section 11.6 for detail.</i>		
Water Sensors	P017653	3	
Inlet Manifold Assembly	P011247	1	
Dump Valve	P011271	1	✓ (1)
Humitter	P011380	1	✓ (1)
Heatless Dryer Assembly	<i>See section 11.3 for detail.</i>		
Check Valve	P010782	1	
Outlet Pressure Regulator	P013203	1	✓ (1)
Static Pressure Regulator	P013203	1	✓ (1)

Pressure Gauge (0-30 PSI)	P011339	1	
Temperature Sensor	P011369	1	
Combo Block		1	

### 11.3 Heatless Dryer Assembly Parts

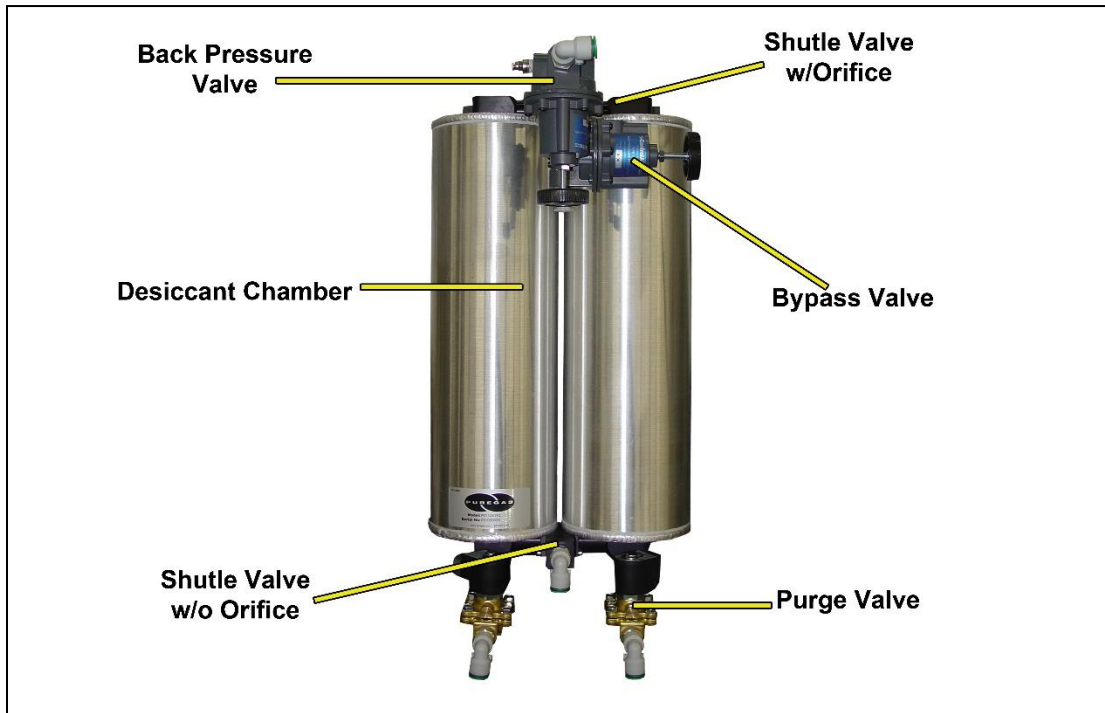

Description	Part Number		Quantity	Recommend Spare
	P10KW	P15KW		
Back Pressure Valve	P011356		1	✓ (1)
Desiccant Chamber			2	
Shuttle Valve w/o Orifice	P011237		1	
Shuttle Valve w/Orifice	P011236F1	P011236F2	1	✓ (1)
Bypass Valve	P011356		1	✓ (1)
Purge Valve	P011377		2	✓ (1)

## 11.4 Lower Section Parts

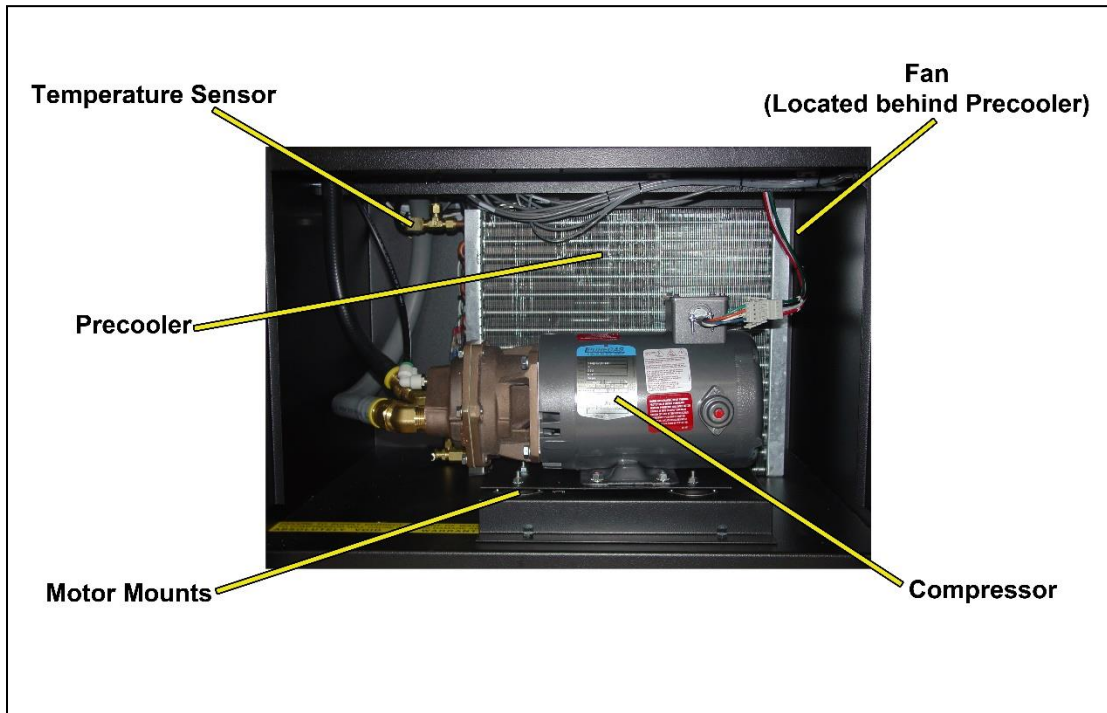

Description	Part Number		Quantity	Recommend Spare
	P10KW	P15KW		
Temperature Sensor	P011369		1	
Precooler	P011299		1	
Motor Mounts	P02626		4	✓ (4)
Fan	P012146		1	
* Fan Kit w/o Precooler	P011701			
Compressor	P011534	P011535	1	✓ (1)

## 11.5 Frame Section Parts

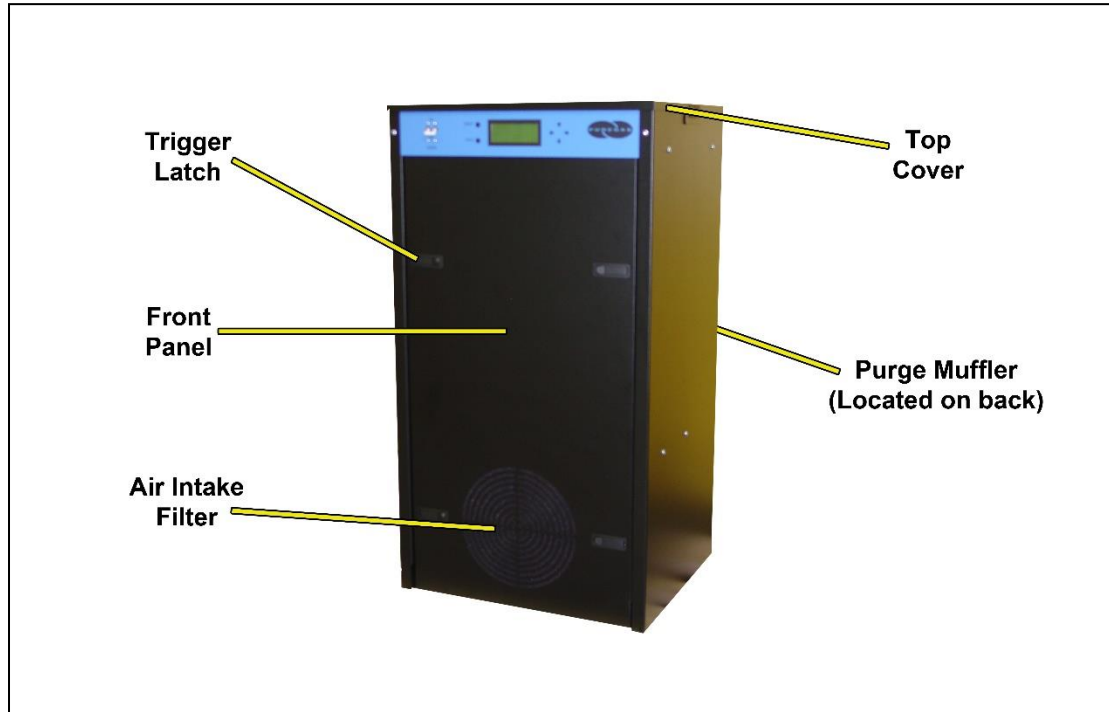

Description	Part Number	Quantity	Recommend Spare
Locking Trigger Latch		6	
Front Panel		1	
Air Intake Filter	<i>In Kit P011297. See section 11.6 for detail.</i>		
Purge Muffler	<i>In Kit P011297. See section 11.6 for detail.</i>		
Top Cover		1	

## 11.6 Accessories for Your Dryer

	Description	Part Number	Recommend Spare
	<p>Installation Kit</p> <p>Includes fittings required to connect to 3/4" flexible hose.</p>	P011890	
	<p>Six Month Maintenance Kit</p> <p>Includes air intake filter, inlet filter, water filter, and water filter housing O-ring.</p>	P011297	✓ (2)
	<p>8000 Hour Maintenance Kit</p> <p>2 Purge Valve Repair Kits</p>	P018194	✓ (1)
	<p>Cycle Kit</p> <p>Allows multiple dryers to be cycled.</p>	P08033W	
	<p>Monitoring Interface</p> <p>Allows the dryer to be fully monitored by ALTEC AIR monitoring systems.</p>	PVDW30	

## 11.7 Ordering Parts from ALTEC AIR



### **IMPORTANT!**

Instruction for the replacement of individual listed components goes beyond the scope of this User's Guide and will not be covered. Please refer to the information included with the specific replacement part for this instruction.

Once you have identified your required parts and accessories, contact the ALTEC AIR Inside Sales / Service department to order:

(800) 521-5351 (option 2)

Fax – (303) 657-2205

[sales@AltecAIR.com](mailto:sales@AltecAIR.com)

[parts@AltecAIR.com](mailto:parts@AltecAIR.com)

## 12. Service & Repair

Only ALTEC AIR can offer factory direct rebuilds backed by a 6-month factory warranty.

- 2-week turnaround time
- Estimates available upon request
- Minimum service charge fee applies

### 12.1 Services Offered

- **Water Sealed Compressor Rebuild**
  - Replace motor bearings, seals & gaskets, impeller & cone
  - Test air flow, air pressure, and electrical performance
- **Circuit Board Repair** (Limited to current model boards only)
- **Complete Dryer Repair**

### 12.2 Initiating a Service Transaction

- Contact our Parts & Service Department at **1-800-521-5351 (option 3)** to obtain a Return Authorization (RA) number.
- Carefully package the item(s) to be returned.
- Mark the Return Authorization (RA) number on the outside of the shipping container.
- Include the main address and phone number of the individual to contact for related inquiry and follow-up information.
- Include the purchase order number.



## 13. Troubleshooting Your Dryer

### 13.1 Before You Call ALTEC AIR

**PLEASE READ THIS SECTION FIRST.** It is important that you use the following sections in order to diagnose and attempt to fix the problem with your air dryer before placing a call to ALTEC AIR Technical Support.

This troubleshooting guide is intended to simplify the isolation of problems, present possible causes, provide test procedures for verification, and suggest corrective actions to restore the air dryer back to normal operation. Each section begins with the most likely cause(s) of the issue. Otherwise, they start from the simplest possibilities and progress to more complicated ones.

This troubleshooting guide is designed to be easy to follow and very effective when used properly. It is suggested to always start at the beginning of the specific problem section and continue in sequence, following the procedures indicated.

### 13.2 Safety & Warning Information



#### **WARNING!**

**For your safety, all the information in this User's Guide must be followed to minimize the risk of electrical shock and prevent property damage or personal injury.**



#### **WARNING!**

**Internal surfaces may be hot.** Use care when coming into contact with internal components as there is a potential for some of these components to become hot when in operation or standby.



**WARNING!**

**Extreme care should be exercised to avoid contact with live electrical circuits.** Many procedures performed during installation, operation, testing, and maintenance of this air dryer require the equipment to be running, creating a situation for potential electrical shock. It is highly recommended that you remove all jewelry before performing any procedures.

**CAUTION!**

Depressurizing the air dryer may be necessary before performing certain procedures. **NEVER** remove pressure sensing tubes from the Control Board without depressurizing the air dryer first, or **damage to the Control Board will occur.**

**CAUTION!**

**Do not test the Humitter with an ohm meter or apply any DC voltage.** This will render the humitter defective.

**WARNING!**

**High Noise.** Altec AIR air dryers are meant to be installed in an unattended area.

**CAUTION!**

Observe precautions for handling **Electrostatic Sensitive Devices.**



### **IMPORTANT!**

Performing procedures not described in this User's Guide or installing components not supplied by ALTEC AIR is NOT RECOMMENDED AND MAY VOID THE WARRANTY.

## 13.3 Air

### Dryer Won't Power ON

Possible Cause	Check	Corrective Action
Circuit Breaker in <b>OFF</b> position	Verify the Circuit Breaker is in <b>ON</b> position (section 8.3 )	Move the Circuit Breakers to <b>ON</b> position (section 8.3 )
No incoming voltage to air dryer	Measure incoming voltage (section 9.4 )	Troubleshoot facility power supply to air dryer

## 13.4 Display Screen Not Functioning

Possible Cause	Check	Corrective Action
Ribbon cable unplugged	Verify that the ribbon cable running from the Control Board to the Display Screen is properly connected at both ends (see section 11.1 for Control Board and Display Screen locations)	Plug in ribbon cable to Control Board and Display Screen (see section 11.1 for Control Board and Display Screen locations)
Defective Display Board	Garbled or no readout with ribbon cable properly connected.	Replace Display Board (section 11.1 )

### 13.5 Low System Pressure Alarm

Possible Cause	Check	Corrective Action
System Pressure set too low	Verify System Pressure ( <b>SYSP</b> ) reading (section 8.4.4.1 )	Adjust Bypass Valve (section 8.11 )
High Flow condition	Verify Flow Rate ( <b>FLOW</b> ) reading is not higher than expected (section 8.4.4.1 )	Troubleshoot High Flow condition (section 13.11)
System Pressure Alarm set point too low	Verify System Pressure Alarm set point (section 8.6.4 )	Raise System Pressure Alarm set point (section 8.6.4 )

### 13.6 Can't Create a Low System Pressure Alarm

Possible Cause	Check	Corrective Action
Defective Bypass Regulator	Verify that the Bypass Valve can be adjusted (section 8.11.1.9 )	Replace Bypass Valve if unable to adjust pressure (section 11.3 )
System Pressure Alarm set point too low	Verify System Pressure Alarm set point (section 8.6.4 )	Adjust Bypass Valve so that System Pressure ( <b>SYSP</b> ) reading drops below verified set point (section 9.7 )
Defective Control Board	Verify that the Outlet Pressure ( <b>OUTP</b> ) reading is lower than the Low Outlet Pressure Alarm set point (above)	Replace Control Board (section 11.1 ) if Outlet Pressure ( <b>OUTP</b> ) reading is under verified Low Outlet Pressure Alarm set point for more than 1 minute and fails to create an alarm.

### 13.7 High Outlet Pressure Alarm

Possible Cause	Check	Corrective Action
Outlet Pressure set too high	Verify Outlet Pressure ( <b>OUTP</b> ) reading (section 8.4.4.1 )	Adjust Outlet Pressure Regulator (section 8.13 )
High Outlet Pressure Alarm set point too low	Verify High Outlet Pressure Alarm set point (section 8.6.2 )	Raise High Outlet Pressure Alarm set point (section 8.6.2 )

### 13.8 Can't Create a High-Pressure Alarm

Possible Cause	Check	Corrective Action
Defective Outlet Pressure Regulator	Verify that the Outlet Pressure Regulator can be adjusted (section 8.13 )	Replace Outlet Pressure Regulator if unable to adjust pressure (section 0)
High Outlet Pressure Alarm set point higher than default setting	Verify High Outlet Pressure Alarm set point (section 8.6.2 )	Adjust Outlet Pressure Regulator so that Outlet Pressure ( <b>OUTP</b> ) reading climbs over verified set point (section 8.13 )
Defective Control Board	Verify that the Outlet Pressure ( <b>OUTP</b> ) reading is higher than the High Outlet Pressure Alarm set point (above)	Replace Control Board (section 11.1 ) if Outlet Pressure ( <b>OUTP</b> ) reading is over verified High Outlet Pressure Alarm set point for more than 1 minute and fails to create an alarm.

### 13.9 Low Outlet Pressure Alarm

Possible Cause	Check	Corrective Action
Outlet Pressure set too low	Verify Outlet Pressure ( <b>OUTP</b> ) reading (section 8.4.4.1 )	Adjust Outlet Pressure Regulator (section 8.13 )
High Flow condition	Verify Flow Rate ( <b>FLOW</b> ) reading is not higher than expected (section 8.4.4.1 )	Troubleshoot High Flow condition (section 13.11 )
Low Outlet Pressure Alarm set point too high	Verify Low Outlet Pressure Alarm set point (section 8.6.3 )	Lower the Low Outlet Pressure Alarm set point (section 8.6.3 )

### 13.10 Can't Create a Low-Pressure Alarm

Possible Cause	Check	Corrective Action
Defective Outlet Pressure Regulator	Verify that the Outlet Pressure Regulator can be adjusted (section 8.13 )	Replace Outlet Pressure Regulator if unable to adjust pressure (section 0)
Low Outlet Pressure Alarm set point lower than default setting	Verify Low Outlet Pressure Alarm set point (section 8.6.3 )	Adjust Outlet Pressure Regulator so that Outlet Pressure ( <b>OUTP</b> ) reading drops below

		verified set point (section 9.6 )
Defective Control Board	Verify that the Outlet Pressure ( <b>OUTP</b> ) reading is lower than the Low Outlet Pressure Alarm set point (above)	Replace Control Board (section 11.1 ) if Outlet Pressure ( <b>OUTP</b> ) reading is under verified Low Outlet Pressure Alarm set point for more than 1 minute and fails to create an alarm.

### 13.11 High Flow Rate Alarm

Possible Cause	Check	Corrective Action
Air leak in downstream cable outside of dryer	Verify Flow Rate ( <b>FLOW</b> ) reading is not higher than expected (section 8.4.4.1 )	Fix downstream problem
Air leak inside of dryer	Test fittings and hoses for leaks (section 9.16 )	Reconnect or replace bad fitting / hose
High Flow Alarm set point too low	Verify High Flow Alarm set point (section 8.6.1 )	Raise High Flow Alarm set point (section 8.6.1 )

### 13.12 High Humidity



#### **CAUTION!**

**Do not test the Humitter with an ohm meter or apply any DC voltage.** This will render the humitter defective.

Possible Cause	Check	Corrective Action
Low System Pressure	Verify System Pressure (section 8.11 )	Adjust System Pressure according to Elevation chart. (section 8.11 )
Low Flow Rate	Verify Flow Rate ( <b>FLOW</b> ) reading is low (section 8.4.4.1 )	Increase flow by creating an artificial leak outside of the air dryer
High Humidity Alarm set point too low	Verify High Humidity Alarm set point (section 8.6.5 )	Raise High Humidity Alarm set point (section 8.6.5 )

	If Flow Rate is low, allowing a higher alarm set point (up to 10%) will allow dryer to run within acceptable levels.	Over 10% not recommended
Heatless Dryer not cycling between towers	Verify consistent Heatless Dryer cycling (section 9.8 )	Troubleshoot Inconsistent Heatless Dryer Cycling condition (section 0)
Defective Control Board	Unplug Humitter from Control Board (see section 11.1 for Control Board location)  Humidity reading should drop to 0%	If Humidity did not drop to 0%, replace Control Board (section 11.1 )
Defective Humitter	Test Humitter operation. (section 9.15 )	Replace Humitter (section 0)

### 13.13 Can't Create a High Humidity Alarm / Shutdown

These troubleshooting steps assume that the Humitter is removed from the Humidity Block during the *Testing Humidity Alarm and System Shutdown* (section 9.15 ) procedures.

Possible Cause	Check	Corrective Action
Humitter Cable disconnected	Verify that Humitter cable is connected to the Control Board	Connect Humitter cable (section 11.1 )
Defective Humitter	Verify that Humidity reading fails to climb higher than 15% or creates sporadic readings	Replace Humitter (section 0)
Defective Control Board	Verify that Humidity reading is over 15% for more than 1 minute	Replace Control Board if no alarm is created and system does not shut down (section 11.1 )

### 13.14 High Outlet Temperature Alarm

Possible Cause	Check	Corrective Action
Fan Failure	Verify fan is running (section 9.10 )	Check for loose fan wiring (section 14.1 )  Replace defective fan (section 11.4 )
High Ambient Temperature	Verify temperature of dryer operating location. Recommended ambient temperature is 40°-85°F.	Lower ambient temperature of dryer operating location

### 13.15 Low Water Alarm

Possible Cause	Check	Corrective Action
Water and/or air leaks in the air dryer	Test fittings and hoses for leaks (section 9.16 )	Connect, tighten, or replace leaking component
Defective water sensors	Test water sensors (section 9.11 , 9.12 , 9.13 )	Replace water sensors as needed
Defective Dump Solenoid	Measure voltages at the Dump Solenoid (section 9.14 )	If voltage is present move to the next step. If no voltage is present and unit still dumps , replace Dump Solenoid (section 0)
Defective Control Board	Measure voltages at the Power Relay Board (section 9.14.6 )	If voltage is measured replace Control Board (section 11.1 )

### 13.16 Can't Create a Low Water Alarm

Possible Cause	Check	Corrective Action
Loose or poor electrical connection	Check wiring connections	Repair or replace any loose or damaged wire connections
Defective Low Water Sensor	Test Low Water Sensor (section 9.11 )	Replace Low Water Sensors (section 0)
Defective Control Board	Verify that the unit is in a low water state	Replace Control Board (section 11.1 ) if unit is in a low water state for more than 1 minute and fails to create an alarm and shut down



### 13.17 High Water Alarm

Possible Cause	Check	Corrective Action
Defective High-Water sensor	Test High Water sensor (section 9.13 )	Replace High water sensor (section 0)
Defective Dump Water sensor	Test Dump Water sensor (section 9.12 )	Replace Dump Water sensor (section 0)
Defective Dump Solenoid	Measure voltages at the Dump Solenoid (section 9.14 )	If voltage is present and unit does not dump, replace Dump Solenoid (section 0). If no voltage is present move to the next step
Defective Control Board	Measure voltages at the Power Relay Board (section 9.14.6 )	If no voltage is measured replace Control Board (section 11.1 )

### 13.18 Can't Create a High-Water Alarm

Possible Cause	Check	Corrective Action
Loose or poor electrical connection	Check wiring connections	Repair or replace any loose or damaged wire connections
Defective High-Water Sensor	Test High Water Sensor (section 9.13 )	Replace High Water Sensors (section 0)
Defective Control Board	Verify that the unit is in a high-water state	Replace Control Board (section 11.1 ) if unit is in a high-water state for more than 1 minute and fails to create an alarm

### 13.19 High Water Temperature Alarm

Possible Cause	Check	Corrective Action
Fan Failure	Verify fan is running (section 9.10 )	Check for loose fan wiring (section 14.1 )  Replace defective fan (section 11.4 )
High Ambient Temperature	Verify temperature of dryer operating location. Recommended ambient temperature is 40°-85°F.	Lower ambient temperature of dryer operating location

### 13.20 Compressor Doesn't Operate

Possible Cause	Check	Corrective Action
Defective compressor	Measure voltage to compressor (section 9.3 )	If voltage is good, replace compressor (section 11.4 ) or send it in for repair (section 12. )
No power to compressor	Measure voltage to compressor (section 9.3 )	If voltage is not present or fluctuates, continue to next Possible Cause
Defective Contactor	Measure voltages at the Contactor (section 14. )	If measurements are good move to the next step. If measurements are bad, replace Contactor (section 11.1 )
Defective Power Relay Board	Measure voltages at the Power Relay Board (section 14. )	If measurements are bad replace board (section 11.1 )
System is in Shutdown state	On the Display Panel, verify that the System is in a Shutdown state (section 8.4.4.3 )	Press the <b>RESET</b> Button

### 13.21 Unit Trips Breaker

Possible Cause	Check	Corrective Action
Loose or defective wiring	Check all wiring for loose or damaged connections	Repair or replace loose or damaged wires
Compressor failing	Measure Compressor AMP Draw (section 9.2 )	If measurement is high replace compressor (section 11.4 ) or send it in for repair (section 12. )
Incorrect Pressure Settings	Review; System, Static and Outlet Pressures	Refer to default values (section 14.2.1), and dryer elevation chart (6.5.23)

### 13.22 Inconsistent Heatless Dryer Cycling

Possible Cause	Check	Corrective Action
Defective Purge Valve	Measure voltage going to the Heatless Dryer Purge Valves (section 9.9 )	If 24 VDC <b>IS</b> present, replace Purge Valves (section 11.3 )
Defective Power Relay Board	Measure voltage going to the Heatless Dryer Purge Valves (section 9.9 )	If 24 VDC <b>IS NOT</b> present, replace the Power Relay Board (section 11.1 )

### 13.23 Contacting ALTEC AIR Technical Support

Please read the *Before You Call ALTEC AIR* section (13.1 )

Once you have exhausted all of the potential problems and solutions covered in the *Troubleshooting Your Dryer* section, and you still require further assistance to correct a problem, contact ALTEC AIR Technical Support:

(800) 521-5351 (option 1)

Have the following information available:

Trouble Ticket # (if following-up on a previous call): \_\_\_\_\_

Technician Name: \_\_\_\_\_ Phone #: \_\_\_\_\_

Model #: **P10KW / P15KW** Serial #: \_\_\_\_\_

Company Name: \_\_\_\_\_ Location Name: \_\_\_\_\_

City: \_\_\_\_\_ State: \_\_\_\_\_



## 14.2 Set Point Limits and Defaults

### 14.2.1 System Adjustments

Description	Minimum Value	Maximum Value	Default Value	Unit of Measurement
System Pressure	18.0	26.0	24.0	PSI
Back Pressure	17.0	25.0	23.0	PSI
Static Pressure	17.0	17.0	17.0	PSI
Outlet Pressure	1.0	15.0	10.0	PSI

### 14.2.2 Alarm Set Points

Description	Minimum Value	Maximum Value	Default Value	Unit of Measurement	Shutdown
High Flow Alarm	100	40,000	4,500	SCFD	
High Outlet Pressure Alarm	0.2	20.0	12.0	PSI	
Low Outlet Pressure Alarm	0.1	19.9	6.5	PSI	
Low System Pressure Alarm	18.0	30.0	18.0	PSI	
High Humidity Alarm	3.0	15.0	10.0	%	YES
High Water Temperature Alarm			150.0	Deg F	YES
High Outlet Temperature Alarm			140.0	Deg F	YES

## 15. Limited Warranty Agreement

ALTEC AIR products carry a one (1) year warranty against defective workmanship and material. This period starts at date of shipment. Not included are the components subject to normal replacement during a year's operating time.

No claims for labor in replacing defective parts or for consequential damages will be allowed. Replacement parts will be invoiced in the regular way, with invoices subject to adjustment after the parts claimed defective are examined at our factory. In addition, no material or parts will be accepted at our factory for in-warranty repairs or credit without previous authorization from ALTEC AIR.

Responsibility for damages incurred in transit will be borne by the user and the user in turn should file any damage claim against the carrier. All warranty items are F.O.B. Broomfield, Colorado. Freight charges are the responsibility of the user.

This warranty shall not apply to any ALTEC AIR product which shall have been repaired or altered in any way by anyone other than ALTEC AIR or authorized personnel so as to affect, in our judgment, its proper functioning or reliability, neither will it apply to any product which has been subject to misuse, negligence, or accident. The installation of unauthorized non ALTEC AIR parts will void the warranty on those ALTEC AIR products.

---

### Registration Reminder

If you haven't already done so, please take a moment to register your ALTEC AIR P10KW / P15KW Air Dryer. **Registering is necessary to activate this Limited Warranty on your product.** Once you register, you are eligible to receive free technical support, as well as updates concerning your ALTEC AIR products.

*See Section 7. for details on Registering Your Dryer.*

## 16. Contacting ALTEC AIR

### 16.1 General

ALTEC AIR, LLC  
226A Commerce Street  
Broomfield, Colorado 80020

(800) 521-5351

(303) 427-3700

Fax – (303) 657-2233

[info@AltecAIR.com](mailto:info@AltecAIR.com)

[www.AltecAIR.com](http://www.AltecAIR.com)

### 16.2 Sales

(800) 521-5351 (**option 2**)

Fax – (303) 657-2205

[sales@AltecAIR.com](mailto:sales@AltecAIR.com)

[parts@AltecAIR.com](mailto:parts@AltecAIR.com)

### 16.3 Service

(800) 521-5351 (**option 3**)

Fax – (303) 657-2205

[service@AltecAIR.com](mailto:service@AltecAIR.com)

### 16.4 Technical Support

(800) 521-5351 (**option 1**)

**DON'T FORGET TO REGISTER YOUR DRYER!**

*See Section 7. for details on Registering Your Dryer.*



